

# SG 1085

---

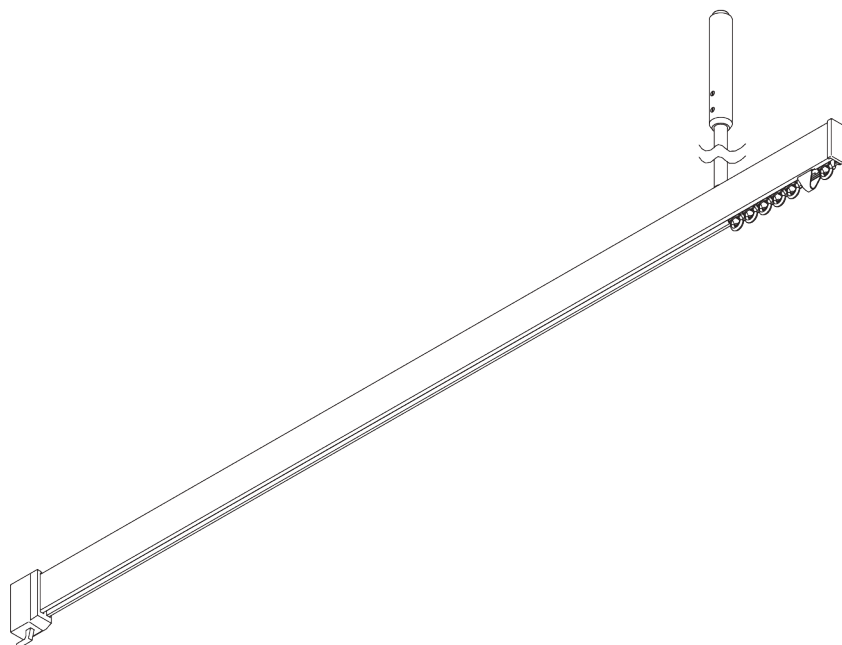
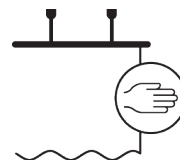

## PRODUCTINFORMATIE

- **Bediening:** hand
- **Groep:** S - M
- **Installatie:** plafond-, wandplaatsing of met pendels
- **Kleuren:** wit gelakt RAL 9016 of aluminium geanodiseerd, andere kleuren op aanvraag
- **Stoffen:** zie Silent Gliss stoffencollectie

### **Kenmerken:**

- Buigbaar
- Ophanging met pendels

# SYSTEEMINFORMATIE

## A. PROFIEL

Profiel- en  
buiginformatie

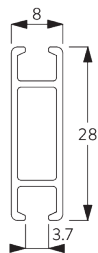

**SG 1085p**

Profiel

✓ Radius:  
20 cm, >28 cm

## B. HOE TE METEN

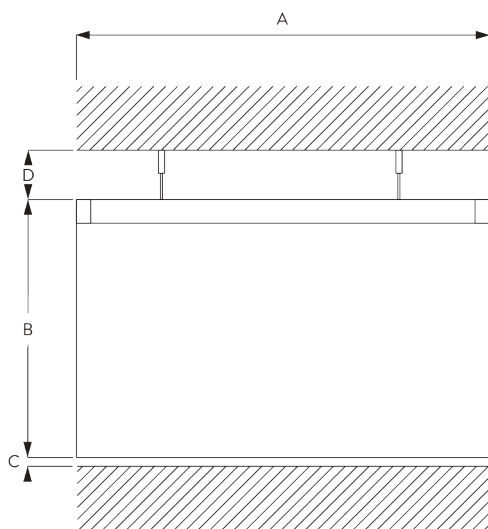

A: Systembreedte

B: Systemhoogte

C: Afstand tussen vloer en onderkant stof

D: Afstand tussen plafond en systeem

# INSTALLATIE

## A. INSTALLATIE INFORMATIE

Bezoek onze *Silent Gliss* website voor gedetailleerde  
installatie informatie.

Bevestigingspunten

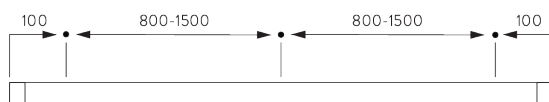

**B. PLAFOND-  
PLAATSING**

**Pendel SG 3625**

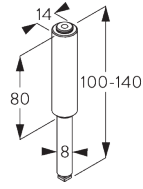
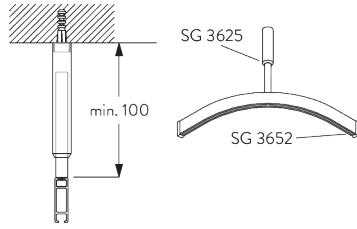

**SG 3625**

*Pendel*

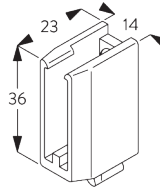

**SG 3652**

*Wandsteun*

**C. WAND-  
PLAATSING**

**Wandsteun SG 3652**

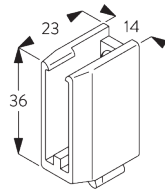
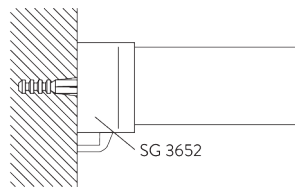

**SG 3652**

*Wandsteun*

**SYSTEMOPTIES**

**A. TOEPASSINGS-  
MOGELIJKHEDEN**

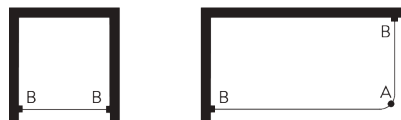
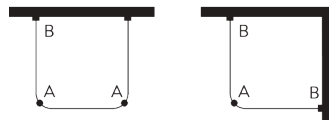



*A: Pendel*



*B: Wandsteun*

# ONDERDELEN

## A. STANDAARD ONDERDELEN

	<b>SG 1085p</b> Profiel
	<b>SG 3070</b> Eindstop met oog
	<b>SG 3085</b> Eindveer
	<b>SG 3533</b> Glijder
	<b>SG 3656</b> Eindstuk (28.2 mm)

## B. OPTIONELE ONDERDELEN

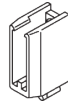
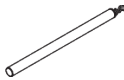
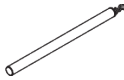
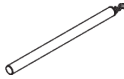
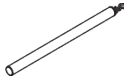
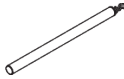
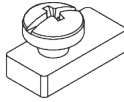
	<b>SG 3534</b> Glijder op strip
	<b>SG 3582</b> Haak
	<b>SG 3625</b> Pendel
	<b>SG 3652</b> Wandsteun
	<b>SG 10430</b> Trekstang (aluminium) met haak, 50 cm
	<b>SG 10431</b> Trekstang (aluminium) met haak, 75 cm
	<b>SG 10432</b> Trekstang (aluminium) met haak, 100 cm
	<b>SG 10433</b> Trekstang (aluminium) met haak, 125 cm
	<b>SG 10434</b> Trekstang (aluminium) met haak, 150 cm
	<b>SG 11335</b> Eindstop