

# DIM-OUT SYSTEMEN

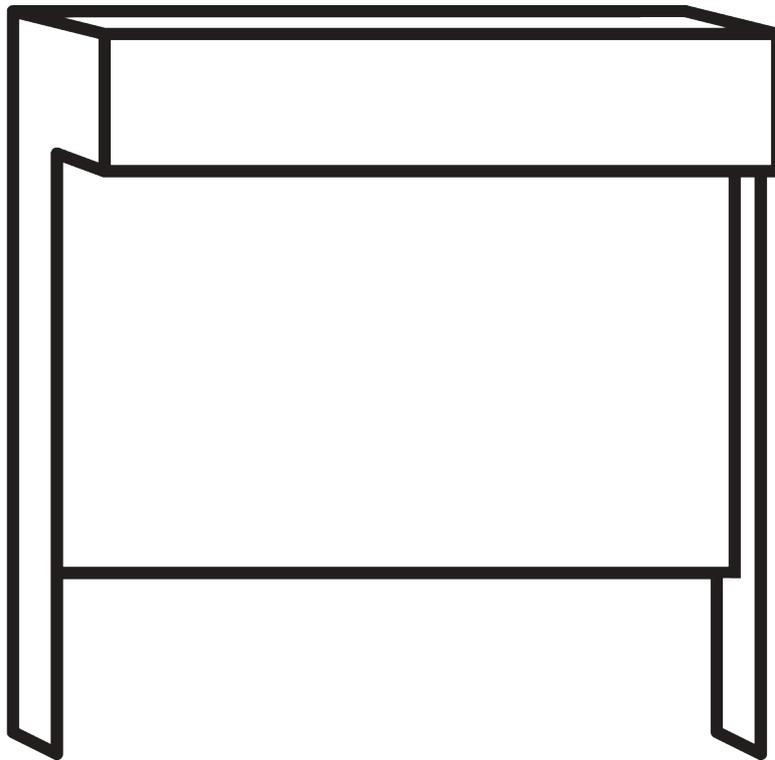

# ALGEMENE OPMERKINGEN

## **Afmetingen**

- De afmetingen zijn in mm, behalve waar aangegeven.
- Het max. gewicht is afhankelijk van de stof incl. onderdelen (verzwaringstaaf, enz.).

## **Installatie**

- Installatie dient te gebeuren door een professionele plaatser.
- Het aantal steunen en bevestigingspunten is afhankelijk van de ondergrond, systeemgewicht, stofkeuze en eventuele obstructies.
- Voor elke situatie dienen de voorziene bevestigingen gebruikt te worden.
- Verhoogde zijde van het profiel, indien aanwezig, is altijd de kamerzijde.
- Aansluitingen moeten worden uitgevoerd volgens de aansluitschema's van Silent Gliss.
- Controleer de ruimte voor kabels en stekkers!

## **Child Safety**

- Alle Silent Gliss systemen voldoen aan de EN 13120 veiligheidsnormen.
- Alle betrokken partijen dienen te voldoen aan de EN 13120 veiligheidsnormen.

# TOEPASSING

<u>PAGINA</u>	<u>SYSTEEM</u>	<u>BEDIENING</u>	<u>AFMETINGEN</u>	← max. →	↑ max. ↓	kg <sub>max.</sub>
5	<b>SG 4710</b>		S	1.6 m	1.6 m	2 kg
13	<b>SG 4730</b>		M	2.2 m	2.4 m	3.7 kg
21	<b>SG 4740</b>		L	3 m	3 m	6 kg
29	<b>SG 4760</b>		S	1.6 m	1.6 m	2 kg
39	<b>SG 4770</b>		M	2.2 m	2.4 m	3.7 kg
49	<b>SG 4780</b>		L	3 m	3 m	6 kg



# SG 4710

---

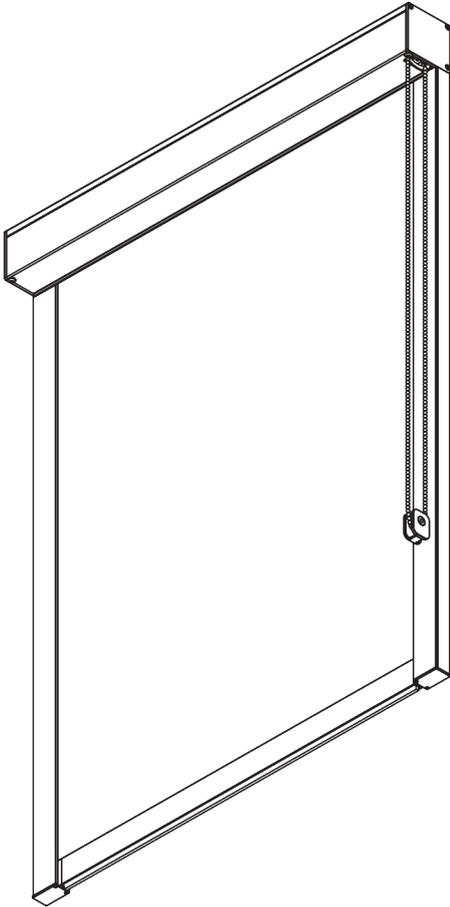
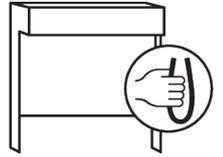

## PRODUCTINFORMATIE

- **Bediening:** ketting
- **Groep:** S
- **Installatie:** plafond-, wandplaatsing of in-de-dag
- **Kleuren:** wit gelakt RAL 9016 of zwart gelakt RAL 9005, andere kleuren op aanvraag
- **Stoffen:** zie Silent Gliss stoffencollectie

### **Kenmerken:**

- Zip technologie
- Roestvrijstalen ketting
- 2:1 aandrijving
- Zijgeleidingsprofiel 40 mm, voorgeboord

# SYSTEEMINFORMATIE

## A. SYSTEEM- AFMETINGEN

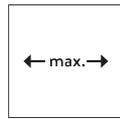

1.6 m

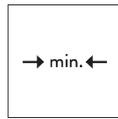

65 cm

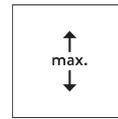

1.6 m



2.5 m<sup>2</sup>

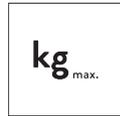

2 kg

## B. PROFIEL

### Profielinformatie

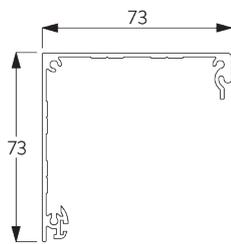

**SG 10994**

Bovenprofiel 73 mm

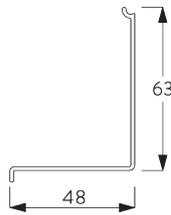

**SG 10995**

Bovenprofiel 73 mm

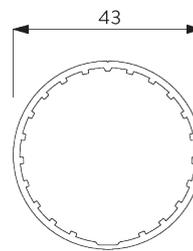

**SG 10532**

Profiel ø 43 mm

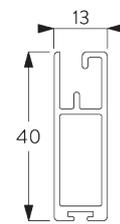

**SG 10993**

Verzwaringsprofiel rechthoek

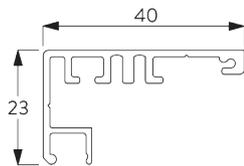

**SG 11418**

Zijgeleidingsprofiel

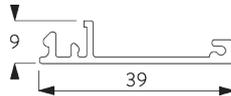

**SG 11419**

Zijgeleidingsprofiel

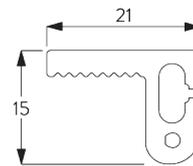

**SG 11421**

Zip profiel

## C. HOE TE METEN

### In-de-dag plaatsing

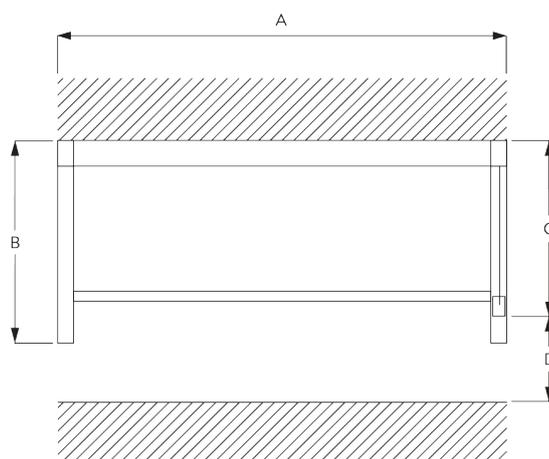

A: Systeembreedte

B: Systeemhoogte

C: Kettinghoogte

D: Safety Retainer SG 10731 min. 150 cm boven de vloer

## Op-de-dag plaatsing

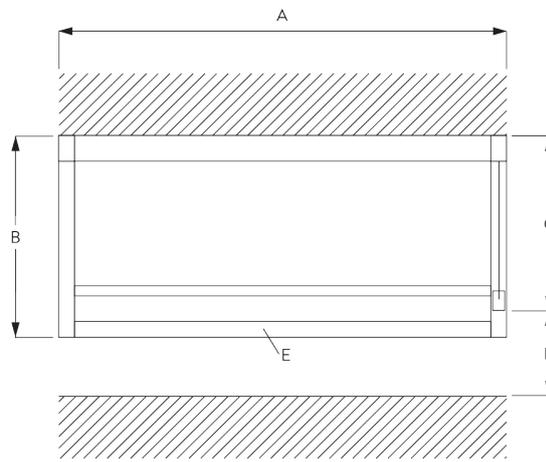

- A: Systeembreedte
- B: Systemhoogte
- C: Kettinghoogte
- D: Safety Retainer SG 10731 min. 150 cm boven de vloer
- E: Optioneel eindprofiel (SG 11418 / SG 11419)

# INSTALLATIE

## A. INSTALLATIE INFORMATIE

Bezoek onze *Silent Gliss* website voor gedetailleerde installatie informatie.

## In-de-dag plaatsing - bevestigingspunten

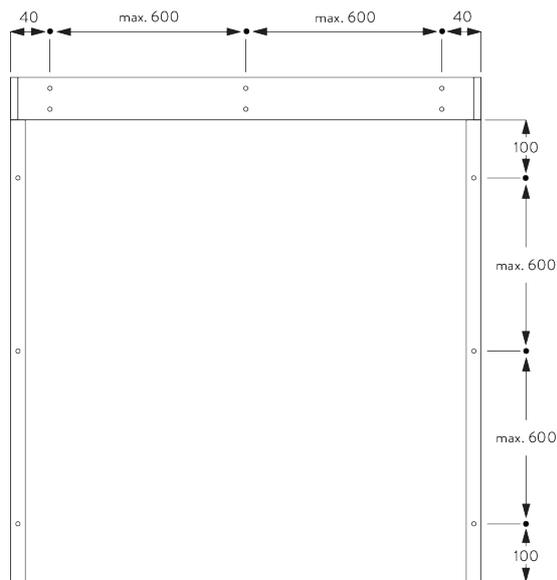

## Op-de-dag plaatsing - bevestigingspunten

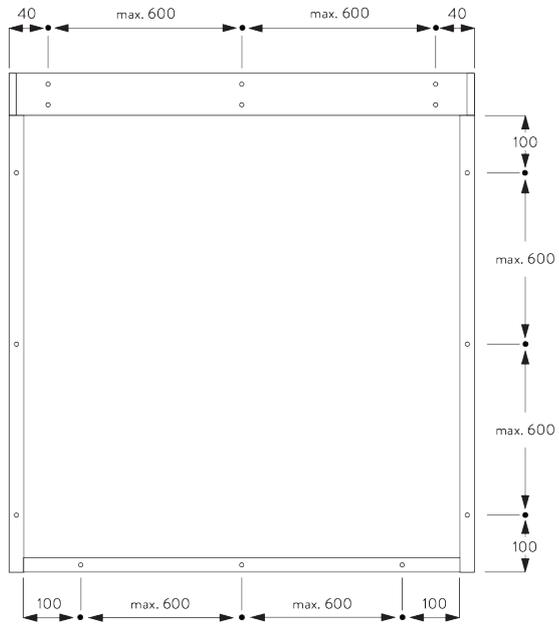

## B. PLAFOND- PLAATSING

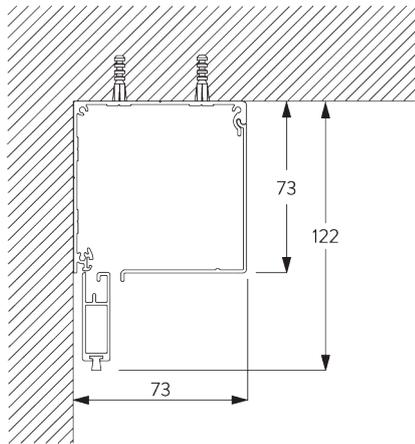

## C. WAND- PLAATSING

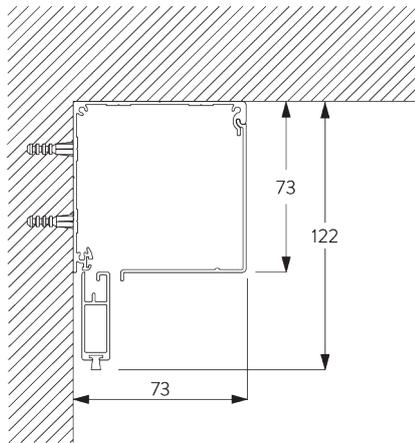

**D. INGEWERKTE  
PLAATSING**

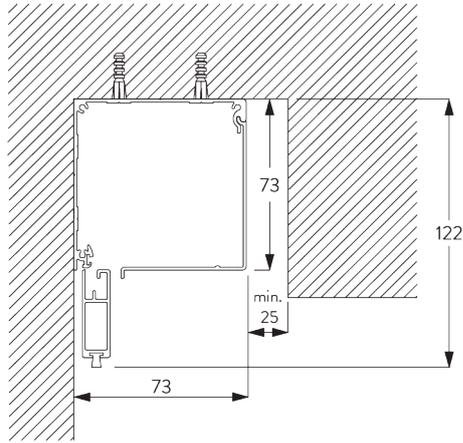

**E. ZIJGELEIDINGS-  
PROFIELEN  
SG 11418 / SG 11419**

**In-de-dag plaatsing**

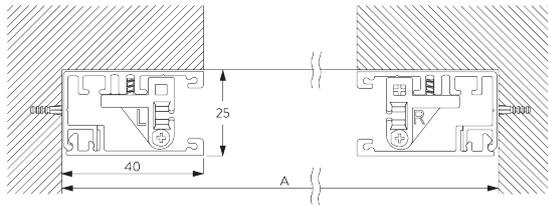

A: Systeembreedte

**Op-de-dag plaatsing**

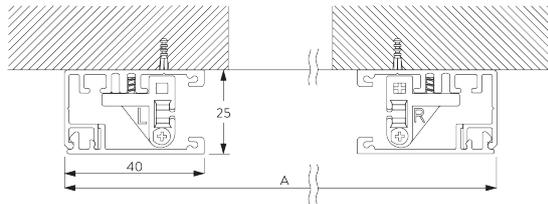

A: Systeembreedte

# ONDERDELEN

## A. STANDAARD ONDERDELEN

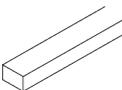
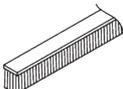
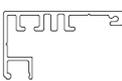
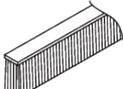
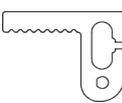
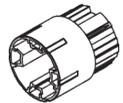
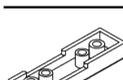
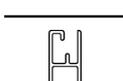
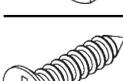
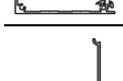
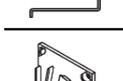
	<b>SG 4226</b> Kleefband 30 mm		<b>SG 11005</b> Afdekkap bovenprofiel rechts 73 mm		<b>SG 11060</b> Foam tape lijm
	<b>SG 4508</b> Borstel 5x7		<b>SG 11010</b> Clip voor aandrijving ketting		<b>SG 11418</b> Zijgeleidingsprofiel
	<b>SG 4509</b> Borstel 5x12		<b>SG 11011</b> Steun		<b>SG 11419</b> Zijgeleidingsprofiel
	<b>SG 6791</b> Schroef 3.9x32		<b>SG 11014</b> Adaptor profiel 41mm		<b>SG 11421</b> Zip profiel
	<b>SG 6933</b> Schroef KA25x16		<b>SG 11015</b> Adaptor profiel 41mm kettingzijde		<b>SG 11473</b> Zip-gids links
	<b>SG 6936</b> Schroef KA22x10		<b>SG 11025</b> Zip band		<b>SG 11474</b> Zip-gids rechts
	<b>SG 6942</b> Schroef KA30x8		<b>SG 11028</b> Eindstuk verzwaringsprofiel links		<b>SG 11475</b> Eindeksel zijgeleider links
	<b>SG 10532</b> Profiel ø 43 mm		<b>SG 11029</b> Eindstuk verzwaringsprofiel rechts		<b>SG 11476</b> Zijgeleiding eindkap rechts
	<b>SG 10668</b> PVC strip en kleefband 10 mm		<b>SG 11030</b> Afdekstuk verzwaringsprofiel		
	<b>SG 10731</b> Safety Retainer set (incl. bevestigingsmiddelen & waarschuwingsboekje)		<b>SG 11031</b> Kettingbediening S		
	<b>SG 10993</b> Verzwaringsprofiel rechthoek		<b>SG 11034</b> Schroef 3.5x16		
	<b>SG 10994</b> Bovenprofiel 73 mm		<b>SG 11035</b> Schroef 2.2x9.5		
	<b>SG 10995</b> Bovenprofiel 73 mm		<b>SG 11040</b> Metalen ketting ø 4.5 mm		
	<b>SG 11004</b> Afdekkap bovenprofiel 73 mm links		<b>SG 11059</b> Schroef M4x12		

## **B. OPTIONELE ONDERDELEN**

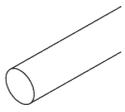

---

**SG 4951**

---

Gewicht

---



# SG 4730

---

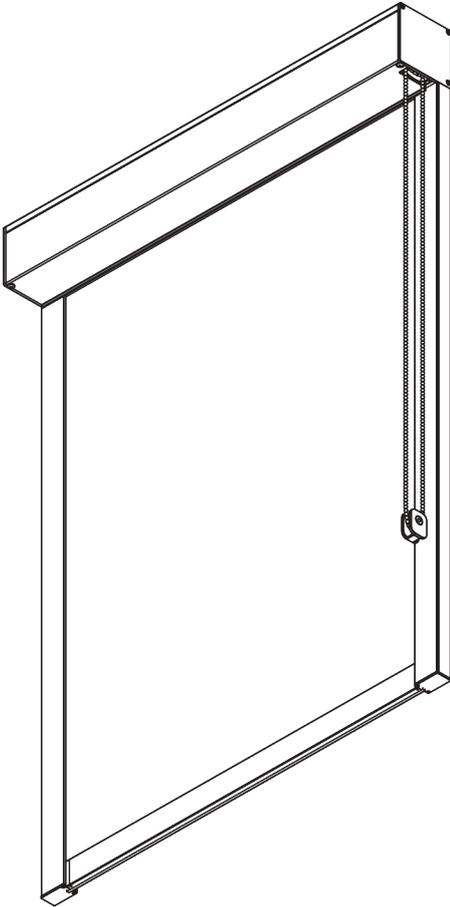
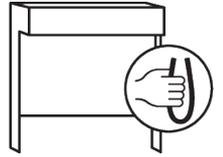

## PRODUCTINFORMATIE

- **Bediening:** ketting
- **Groep:** M
- **Installatie:** plafond-, wandplaatsing of in-de-dag
- **Kleuren:** wit gelakt RAL 9016 of zwart gelakt RAL 9005, andere kleuren op aanvraag
- **Stoffen:** zie Silent Gliss stoffencollectie

### **Kenmerken:**

- Zip technologie
- Roestvrijstalen ketting
- 2:1 aandrijving
- Zijgeleidingsprofiel 40 mm, voorgeboord

# SYSTEEMINFORMATIE

## A. SYSTEEM- AFMETINGEN

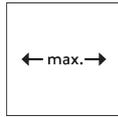

2.2 m

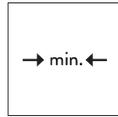

65 cm

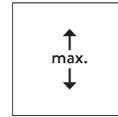

2.4 m



5.3 m<sup>2</sup>



3.7 kg

## B. PROFIEL

### Profielinformatie

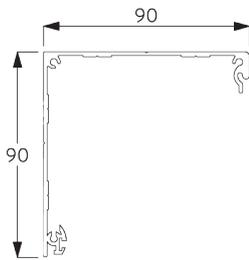

**SG 10996**

Bovenprofiel 90 mm

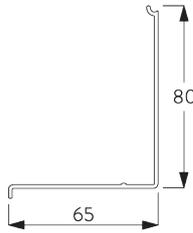

**SG 10997**

Bovenprofiel 90 mm

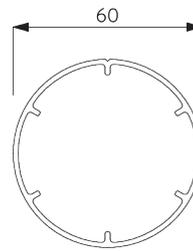

**SG 11037**

Profiel

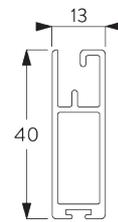

**SG 10993**

Verzwaringsprofiel rechthoek

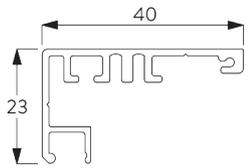

**SG 11418**

Zijgeleidingsprofiel

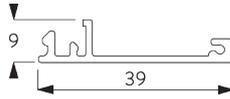

**SG 11419**

Zijgeleidingsprofiel

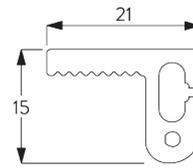

**SG 11421**

Zip profiel

## C. HOE TE METEN

### In-de-dag plaatsing

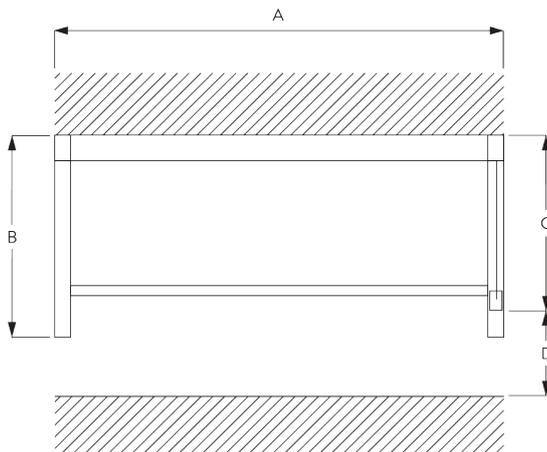

A: Systeembreedte

B: Systeemhoogte

C: Kettinghoogte

D: Safety Retainer SG 10731 min. 150 cm boven de vloer

## Op-de-dag plaatsing

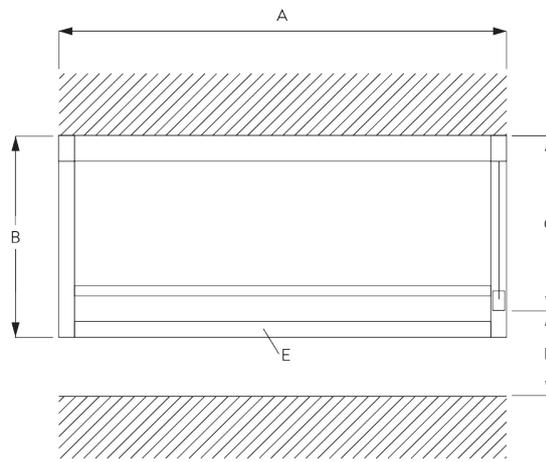

A: Systeembreedte

B: Systemhoogte

C: Kettinghoogte

D: Safety Retainer SG 10731 min. 150 cm boven de vloer

E: Optioneel eindprofiel (SG 11418 / SG 11419)

# INSTALLATIE

## A. INSTALLATIE INFORMATIE

Bezoek onze *Silent Gliss* website voor gedetailleerde installatie informatie.

## In-de-dag plaatsing - bevestigingspunten

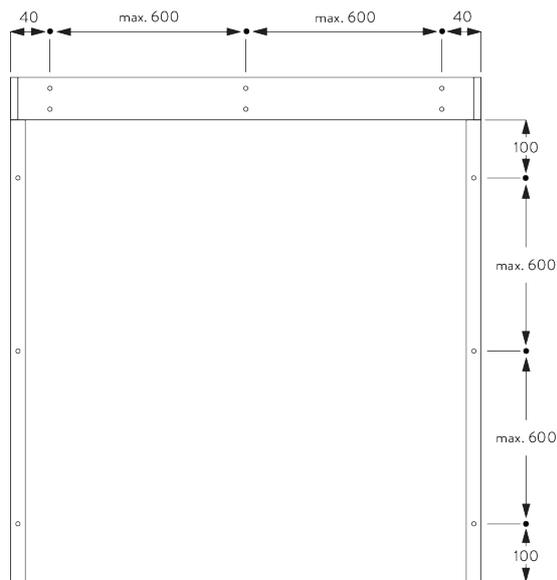

**Op-de-dag plaatsing -  
bevestigingspunten**

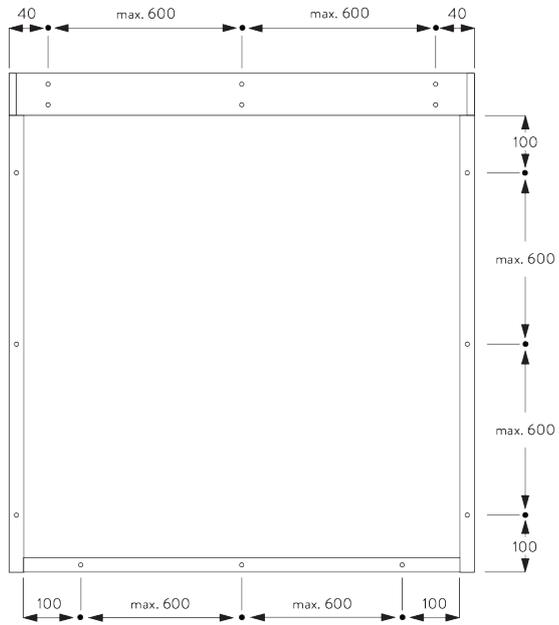

**B. PLAFOND-  
PLAATSING**

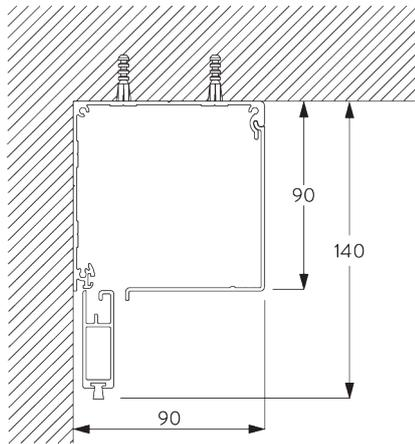

**C. WAND-  
PLAATSING**

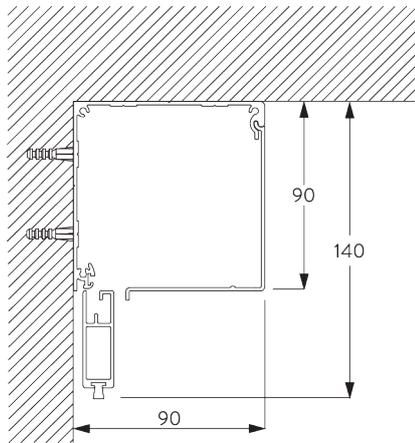

**D. INGEWERKTE  
PLAATSING**

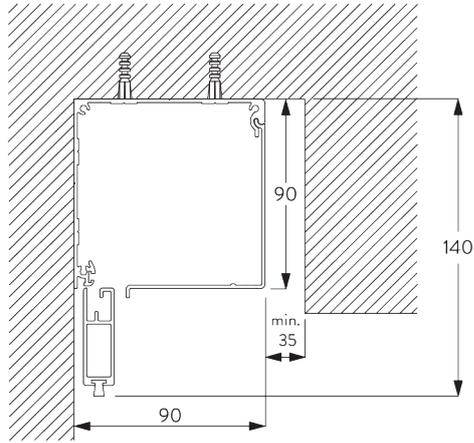

**E. ZIJGELEIDINGS-  
PROFIELEN  
SG 11418 / SG 11419**

**In-de-dag plaatsing**

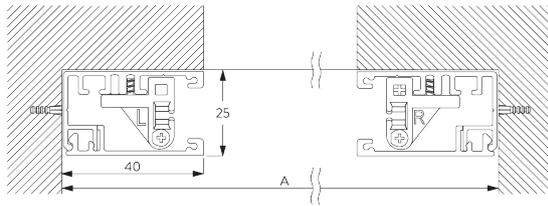

A: Systeembreedte

**Op-de-dag plaatsing**

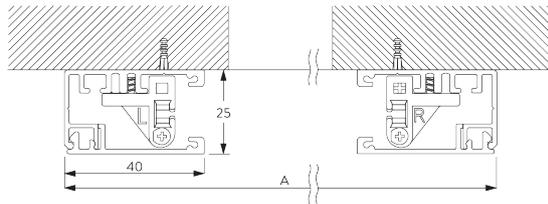

A: Systeembreedte

# ONDERDELEN

## A. STANDAARD ONDERDELEN

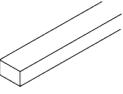
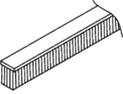
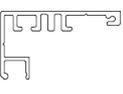
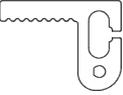
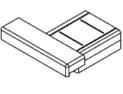
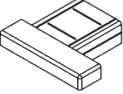
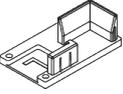
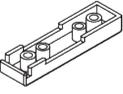
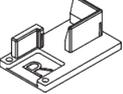
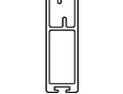
	<b>SG 4226</b> Kleefband 30 mm		<b>SG 11011</b> Steun		<b>SG 11060</b> Foam tape lijm
	<b>SG 4508</b> Borstel 5x7		<b>SG 11012</b> Steun		<b>SG 11418</b> Zijgeleidingsprofiel
	<b>SG 4509</b> Borstel 5x12		<b>SG 11017</b> Adapter profiel 60 mm		<b>SG 11419</b> Zijgeleidingsprofiel
	<b>SG 6791</b> Schroef 3.9x32		<b>SG 11018</b> Adapter profiel 60 mm kettingzijde		<b>SG 11421</b> Zip profiel
	<b>SG 6933</b> Schroef KA25x16		<b>SG 11025</b> Zip band		<b>SG 11473</b> Zip-gids links
	<b>SG 6936</b> Schroef KA22x10		<b>SG 11028</b> Eindstuk verzwaringsprofiel links		<b>SG 11474</b> Zip-gids rechts
	<b>SG 6942</b> Schroef KA30x8		<b>SG 11029</b> Eindstuk verzwaringsprofiel rechts		<b>SG 11475</b> Eindkessel zijgeleider links
	<b>SG 10668</b> PVC strip en kleefband 10 mm		<b>SG 11030</b> Afdekstuk verzwaringsprofiel		<b>SG 11476</b> Zijgeleiding eindkap rechts
	<b>SG 10731</b> Safety Retainer set (incl. bevestigingsmiddelen & waarschuwingsboekje)		<b>SG 11032</b> Kettingbediening Medium		
	<b>SG 10993</b> Verzwaringsprofiel rechthoek		<b>SG 11034</b> Schroef 3.5x16		
	<b>SG 10996</b> Bovenprofiel 90 mm		<b>SG 11035</b> Schroef 2.2x9.5		
	<b>SG 10997</b> Bovenprofiel 90 mm		<b>SG 11037</b> Profiel		
	<b>SG 11006</b> Afdekkap bovenprofiel 90 mm links		<b>SG 11040</b> Metalen ketting ø 4.5 mm		
	<b>SG 11007</b> Afdekkap bovenprofiel 90 mm rechts		<b>SG 11059</b> Schroef M4x12		

## **B. OPTIONELE ONDERDELEN**

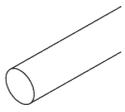

**SG 4951**

Gewicht



**SG 11050**

Veer 60mm links



**SG 11051**

Veer 60mm rechts



# SG 4740

---

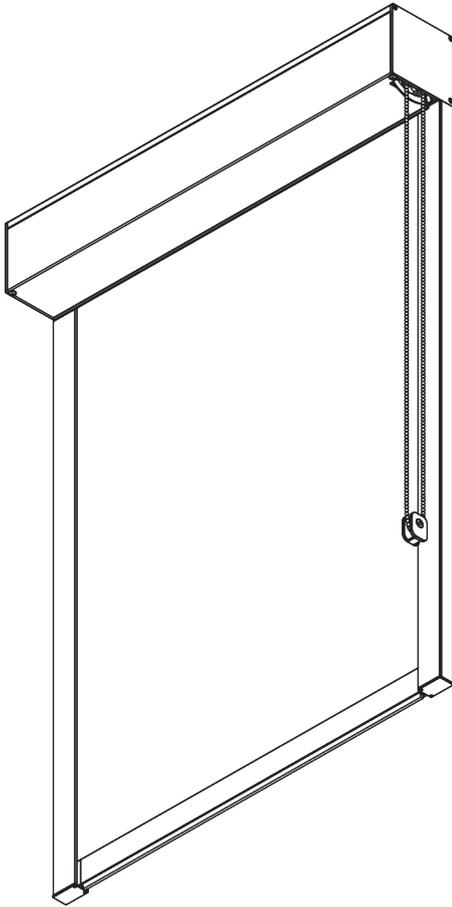
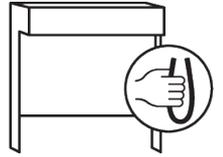

## PRODUCTINFORMATIE

- **Bediening:** ketting
- **Groep:** L
- **Installatie:** plafond-, wandplaatsing of in-de-dag
- **Kleuren:** wit gelakt RAL 9016 of zwart gelakt RAL 9005, andere kleuren op aanvraag
- **Stoffen:** zie Silent Gliss stoffencollectie

### **Kenmerken:**

- Zip technologie
- Roestvrijstalen ketting
- 2:1 aandrijving
- Zijgeleidingsprofiel 40 mm, voorgeboord

# SYSTEEMINFORMATIE

## A. SYSTEEM- AFMETINGEN

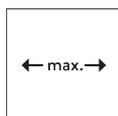

3 m

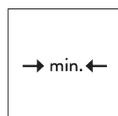

65 cm

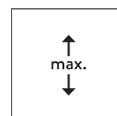

3 m



9 m<sup>2</sup>



6 kg

## B. PROFIEL

### Profielinformatie

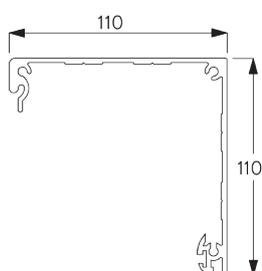

**SG 10998**

Bovenprofiel 110 mm

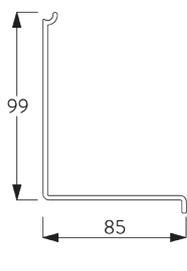

**SG 10999**

Bovenprofiel 110 mm

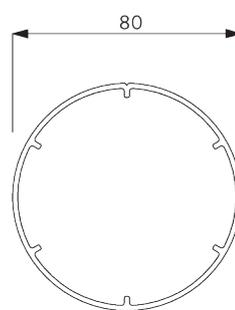

**SG 11003**

Profiel

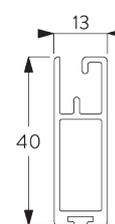

**SG 10993**

Verzwaringsprofiel rechthoek

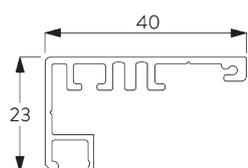

**SG 11418**

Zijgeleidingsprofiel

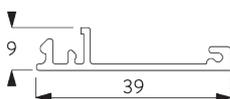

**SG 11419**

Zijgeleidingsprofiel

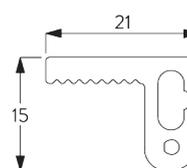

**SG 11421**

Zip profiel

## C. HOE TE METEN

### In-de-dag plaatsing

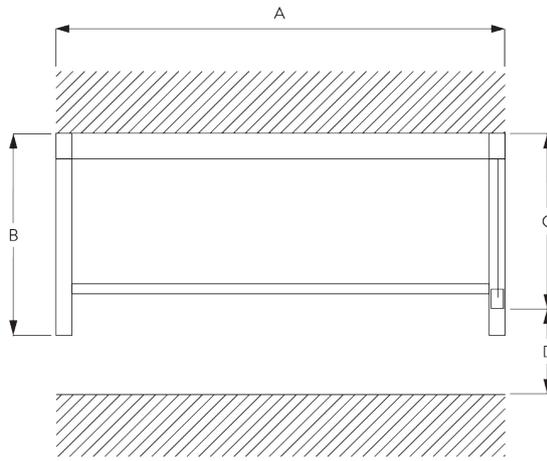

- A: Systeembreedte
- B: Systemhoogte
- C: Kettinghoogte
- D: Safety Retainer SG 10731 min. 150 cm boven de vloer

### Op-de-dag plaatsing

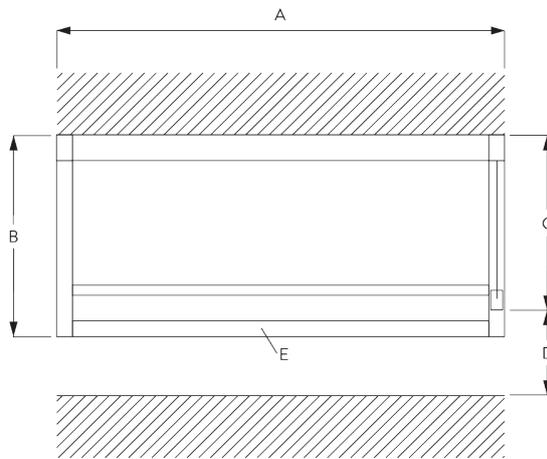

- A: Systeembreedte
- B: Systemhoogte
- C: Kettinghoogte
- D: Safety Retainer SG 10731 min. 150 cm boven de vloer
- E: Optioneel eindprofiel (SG 11418 / SG 11419)

# INSTALLATIE

## A. INSTALLATIE INFORMATIE

Bezoek onze *Silent Gliss* website voor gedetailleerde installatie informatie.

### In-de-dag plaatsing - bevestigingspunten

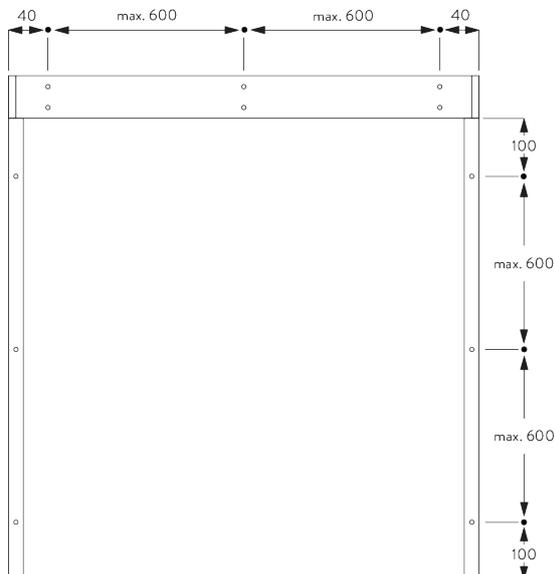



**D. INGEWERKTE  
PLAATSING**

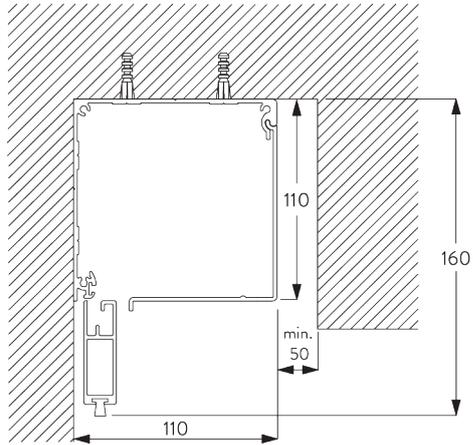

**E. ZIJGELEIDINGS-  
PROFIELEN  
SG 11418 / SG 11419**

**In-de-dag plaatsing**

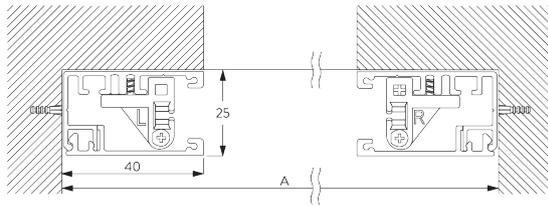

A: Systeembreedte

**Op-de-dag plaatsing**

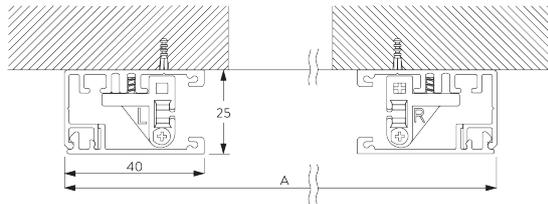

A: Systeembreedte

# ONDERDELEN

## A. STANDAARD ONDERDELEN

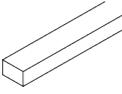
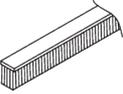
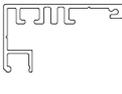
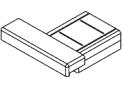
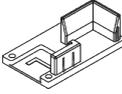
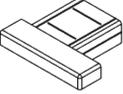
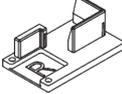
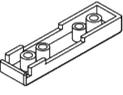
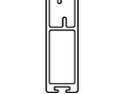
	<b>SG 4226</b> Kleefband 30 mm		<b>SG 11009</b> Afdekkap bovenprofiel 110 mm rechts		<b>SG 11060</b> Foam tape lijm
	<b>SG 4508</b> Borstel 5x7		<b>SG 11011</b> Steun		<b>SG 11418</b> Zijgeleidingsprofiel
	<b>SG 4509</b> Borstel 5x12		<b>SG 11012</b> Steun		<b>SG 11419</b> Zijgeleidingsprofiel
	<b>SG 6791</b> Schroef 3.9x32		<b>SG 11020</b> Adapter profiel 80 mm		<b>SG 11421</b> Zip profiel
	<b>SG 6933</b> Schroef KA25x16		<b>SG 11021</b> Adapter profiel 80 mm kettingzijde		<b>SG 11473</b> Zip-gids links
	<b>SG 6936</b> Schroef KA22x10		<b>SG 11025</b> Zip band		<b>SG 11474</b> Zip-gids rechts
	<b>SG 6942</b> Schroef KA30x8		<b>SG 11028</b> Eindstuk verzwaringsprofiel links		<b>SG 11475</b> Eindeksel zijgeleider links
	<b>SG 10668</b> PVC strip en kleefband 10 mm		<b>SG 11029</b> Eindstuk verzwaringsprofiel rechts		<b>SG 11476</b> Zijgeleiding eindkap rechts
	<b>SG 10731</b> Safety Retainer set (incl. bevestigingsmiddelen & waarschuwingsboekje)		<b>SG 11030</b> Afdekstuk verzwaringsprofiel		
	<b>SG 10993</b> Verzwaringsprofiel rechthoek		<b>SG 11033</b> Kettingbediening L		
	<b>SG 10998</b> Bovenprofiel 110 mm		<b>SG 11034</b> Schroef 3.5x16		
	<b>SG 10999</b> Bovenprofiel 110 mm		<b>SG 11035</b> Schroef 2.2x9.5		
	<b>SG 11003</b> Profiel		<b>SG 11040</b> Metalen ketting ø 4.5 mm		
	<b>SG 11008</b> Afdekkap bovenprofiel 110 mm links		<b>SG 11059</b> Schroef M4x12		

## **B. OPTIONELE ONDERDELEN**

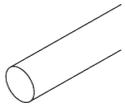

**SG 4951**

Gewicht



**SG 11052**

Veer 80mm links



**SG 11053**

Veer 80mm rechts



# SG 4760

---

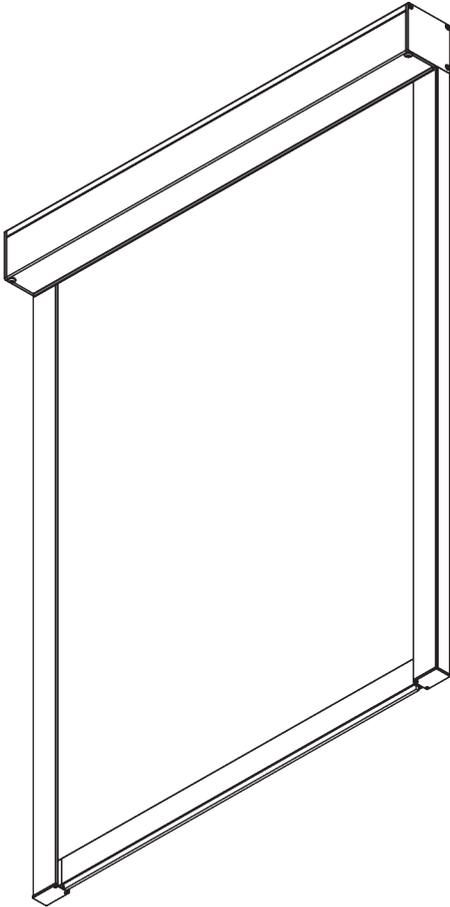
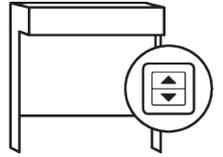

## PRODUCTINFORMATIE

- **Bediening:** elektrisch
- **Groep:** S
- **Installatie:** plafond-, wandplaatsing of in-de-dag
- **Kleuren:** wit gelakt RAL 9016 of zwart gelakt RAL 9005, andere kleuren op aanvraag
- **Stoffen:** zie Silent Gliss stoffencollectie

### **Kenmerken:**

- Zip technologie
- Stille en snelle motoren
- Soft stop
- Verschillende bedieningsmogelijkheden
- Zijgeleidingsprofiel 40 mm, voorgeboord

# SYSTEEMINFORMATIE

## A. SYSTEEM- AFMETINGEN

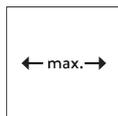

1.6 m

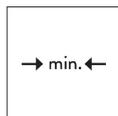

65 cm\*  
\*zie informatie motor



1.6 m

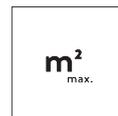

2.5 m<sup>2</sup>



2 kg

## B. PROFIEL

### Profielinformatie

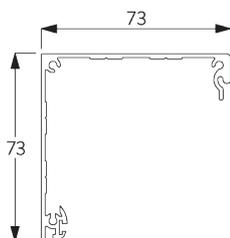

**SG 10994**

Bovenprofiel 73 mm

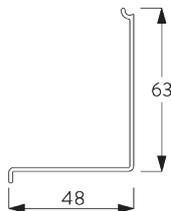

**SG 10995**

Bovenprofiel 73 mm

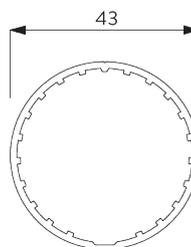

**SG 10532**

Profiel ø 43 mm

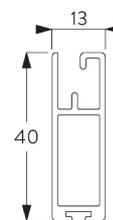

**SG 10993**

Verzwaringsprofiel rechthoek

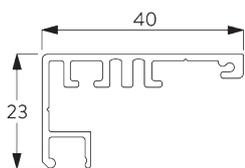

**SG 11418**

Zijgeleidingsprofiel

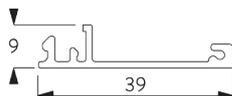

**SG 11419**

Zijgeleidingsprofiel

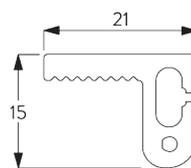

**SG 11421**

Zip profiel

## C. HOE TE METEN

### In-de-dag plaatsing

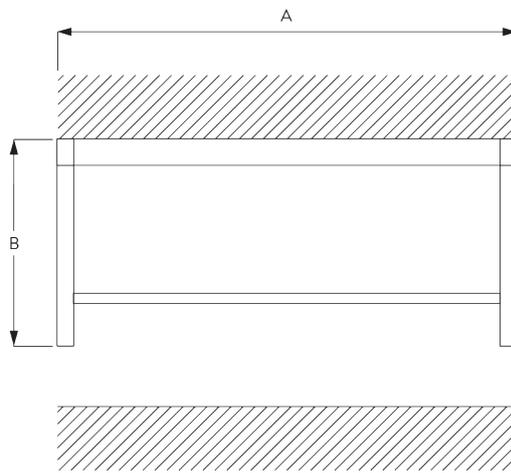

A: Systeembreedte  
B: Systeemhoogte

### Op-de-dag plaatsing

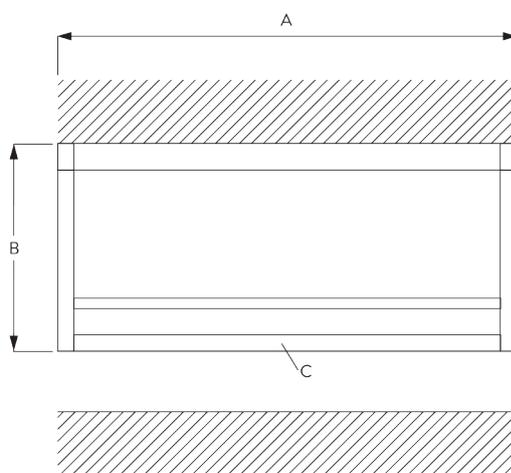

A: Systeembreedte  
B: Systeemhoogte  
C: Optioneel eindprofiel (SG 11418 / SG 11419)

# INSTALLATIE

## A. INSTALLATIE INFORMATIE

Bezoek onze *Silent Gliss* website voor gedetailleerde installatie informatie.

### In-de-dag plaatsing - bevestigingspunten

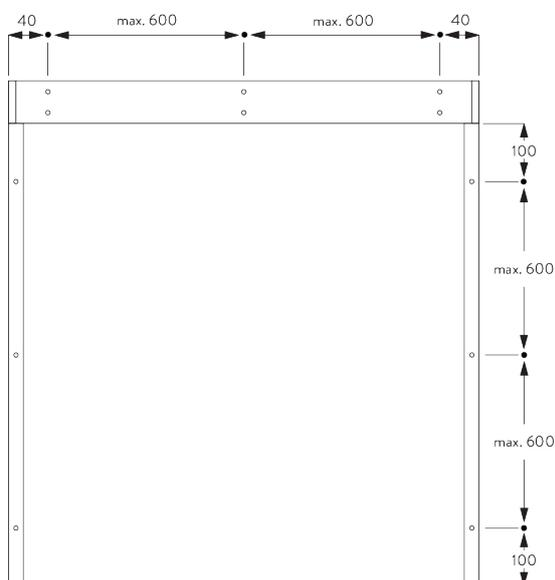

## Op-de-dag plaatsing - bevestigingspunten

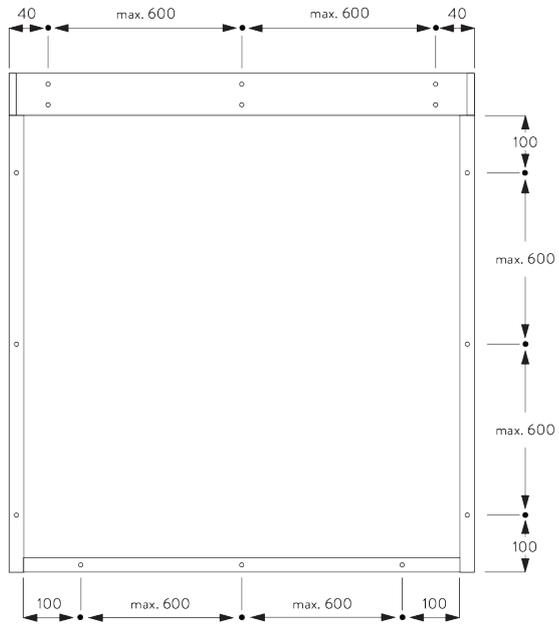

## B. PLAFOND- PLAATSING

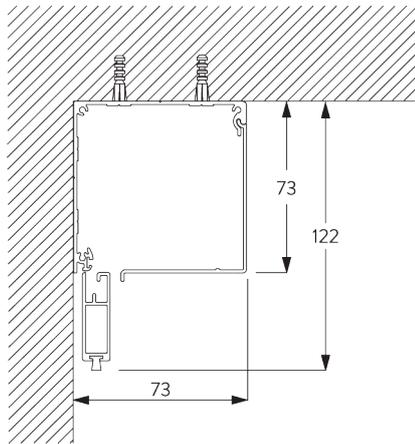

## C. WAND- PLAATSING

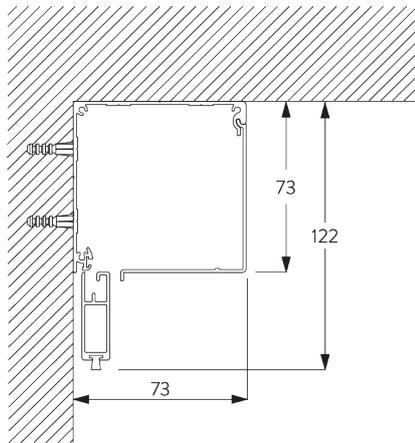

**D. INGEWERKTE  
PLAATSING**

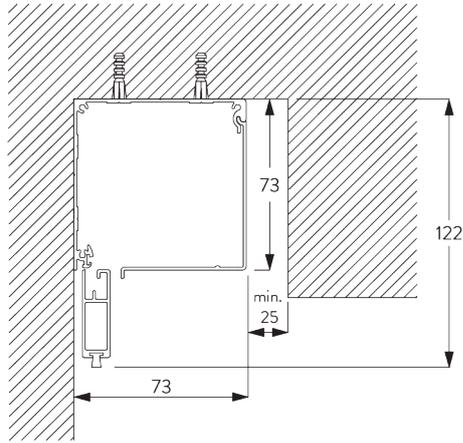

**E. ZIJGELEIDINGS-  
PROFIELEN  
SG 11418 / SG 11419**

**In-de-dag plaatsing**

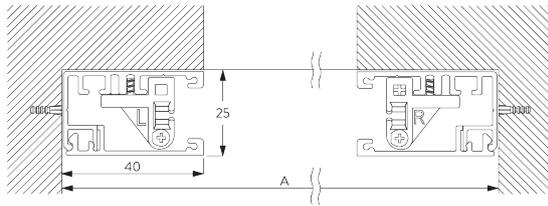

A: Systeembreedte

**Op-de-dag plaatsing**

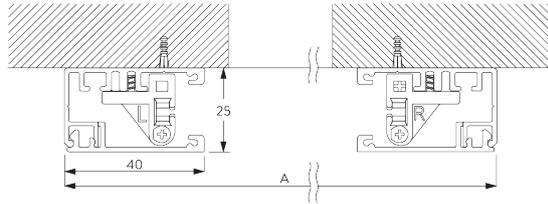

A: Systeembreedte

# MOTOREN EN BESTURINGSMOGELIJKHEDEN

## A. KENMERKEN

### MOTOR

Motoren	50-Series	20-Series	20-Series	10-Series K	5-Series
	SG 11251	SG 10523	SG 10522	SG 10514	SG 10715

#### Kenmerken

Soft stop	•	•	•		
Elektronische eindstop	•	•	•		
Electronic revolution counter (unlimited revolution)	•	•	•		
Mechanische eindstop				•	•
Mechanical revolution counter (limited revolution)				•	•
Twee tussenposities mogelijk		•			
Uitlijnen van de verzwaringsstaaf	•				
Geruisloze stop		•	•	•	
Parallelschakeling mogelijk zonder bijkomende relais		•	•		
Plug-in motorkabel	•	•	•		
IP klasse	IP 30	IP 44	IP 44	IP 44	IP 44

#### Aansturingsmogelijkheden

Netspanningsregeling		•	•	•	•
SG Control L (met ontvanger)		•			
Smart by Silent Gliss	•				
Geschikt voor alle domotica systemen		•	•	•	•

## B. INFORMATIE

### MOTOR

Motoren	Min. systeem breedte	Voltage	Ampère	Frequentie	Snelheid	Frequentie ontvanger
<b>50-Series (Smart by Silent Gliss)</b>						
SG 11251	65 cm	24 V DC	1.5 A	-	32 rpm	-
<b>20-Series</b>						
SG 10522 (standaard)	65 cm	230 V AC	0.55 A	50 Hz	30 rpm	-
SG 10523	65 cm	230 V AC	0.55 A	50 Hz	30 rpm	868/915 MHz
<b>10-Series K</b>						
SG 10514	65 cm	230 V AC	0.52 A	50 Hz	30 rpm	-
<b>5-Series</b>						
SG 10715	65 cm	230 V AC	0.485 A	50-60 Hz	28 rpm	-

## C. BESTURINGS- MOGELIJKHEDEN

Zie catalogus "controles" voor details.

**Wandschakelaar**



*Systeem kan worden bediend met vaste wandschakelaar.*

**SG Control L**



*Diverse draadloze hand- en wandzenders beschikbaar.*



*Silent Gliss Move App.*

**Smart by Silent Gliss**



*Open ontworpen tweewegcommunicatiesysteem waarmee de producten feilloos kunnen worden geïntegreerd met de meeste grote gebouwbeheersystemen.*

**D. AANSLUIT-  
SCHEMA'S**



*Raadpleeg onze Silent Gliss-website.*

# ONDERDELEN

## A. STANDAARD ONDERDELEN

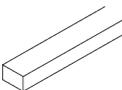
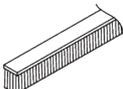
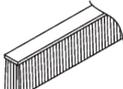
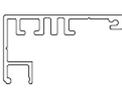
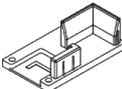
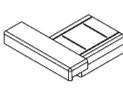
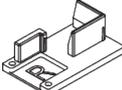
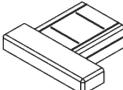
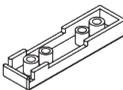
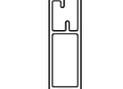
	<b>SG 4226</b> Kleefband 30 mm		<b>SG 10995</b> Bovenprofiel 73 mm		<b>SG 11060</b> Foam tape lijm
	<b>SG 4508</b> Borstel 5x7		<b>SG 11004</b> Afdekkap bovenprofiel 73 mm links		<b>SG 11324</b> Schroef KA35x14
	<b>SG 4509</b> Borstel 5x12		<b>SG 11005</b> Afdekkap bovenprofiel rechts 73 mm		<b>SG 11418</b> Zijgeleidingsprofiel
	<b>SG 6791</b> Schroef 3.9x32		<b>SG 11011</b> Steun		<b>SG 11419</b> Zijgeleidingsprofiel
	<b>SG 6933</b> Schroef KA25x16		<b>SG 11013</b> Steun motor		<b>SG 11421</b> Zip profiel
	<b>SG 6936</b> Schroef KA22x10		<b>SG 11014</b> Adaptor profiel 41mm		<b>SG 11473</b> Zip-gids links
	<b>SG 6942</b> Schroef KA30x8		<b>SG 11016</b> Adapter profiel 41 mm motorzijde		<b>SG 11474</b> Zip-gids rechts
	<b>SG 9917</b> Hirschmann contra stekker		<b>SG 11025</b> Zip band		<b>SG 11475</b> Einddeksel zijgeleider links
	<b>SG 10284</b> Ring		<b>SG 11028</b> Eindstuk verzwaringsprofiel links		<b>SG 11476</b> Zijgeleiding eindkap rechts
	<b>SG 10522</b> Motor 230V AC, 20-Series S 3/30		<b>SG 11029</b> Eindstuk verzwaringsprofiel rechts		
	<b>SG 10532</b> Profiel ø 43 mm		<b>SG 11030</b> Afdekstuk verzwaringsprofiel		
	<b>SG 10668</b> PVC strip en kleefband 10 mm		<b>SG 11034</b> Schroef 3.5x16		
	<b>SG 10993</b> Verzwaringsprofiel rechthoek		<b>SG 11035</b> Schroef 2.2x9.5		
	<b>SG 10994</b> Bovenprofiel 73 mm		<b>SG 11059</b> Schroef M4x12		

## B. OPTIONELE ONDERDELEN

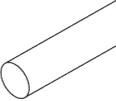
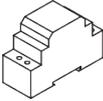
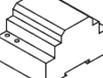
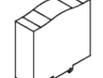
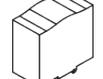
	<b>SG 4951</b> Gewicht		<b>SG 11263</b> Voeding 24V DC, 2.5 Ampère DIN rail
	<b>SG 9916</b> Hirschmann stekkerzet		<b>SG 11264</b> Voeding 24V DC, 3.8 Ampère DIN rail
	<b>SG 10293</b> Aansluitkabel 3, 5 en 10 m optioneel		<b>SG 11265</b> Voeding 24V DC, 5 Ampère DIN rail
	<b>SG 10300</b> Afstandsbediening, 1 kanaal		<b>SG 11266</b> Voeding 24V DC, 10 Ampère DIN rail
	<b>SG 10302</b> Afstandsbediening, 5+1 kanaal		<b>SG 11460</b> Afdekking voor Hirschmann-stekker
	<b>SG 10303</b> Afstandsbediening, 10+2+1 kanalen		<b>SG 11480</b> Wandchakelaar 1 kanaal
	<b>SG 10514</b> Motor 230V AC, 10 Series S 3/30 K		<b>SG 11490</b> Wandchakelaar 5+1 kanaal
	<b>SG 10523</b> Motor 230V AC, 20-Series S 3/30, radio ontvanger		
	<b>SG 10715</b> Motor 230V AC, 5 Series S 6/28		
	<b>SG 10804</b> Afstandsbediening 15 kanalen		
	<b>SG 11251</b> Motor 24V DC, 50-Series S 3/32		
	<b>SG 11260</b> Gateway Cedia		
	<b>SG 11261</b> Gateway KNX		
	<b>SG 11262</b> Uitbreidingseenheid		



# SG 4770

---

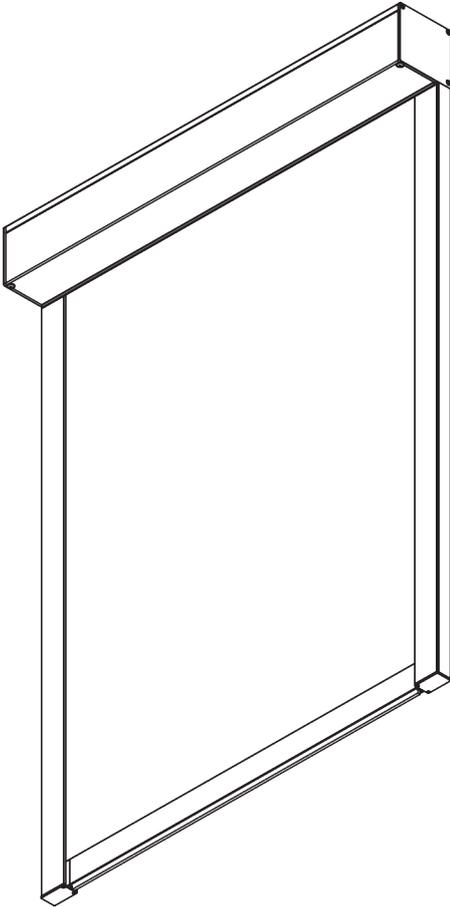
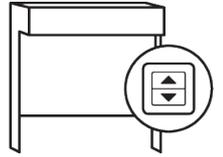

## PRODUCTINFORMATIE

- **Bediening:** elektrisch
- **Groep:** M
- **Installatie:** plafond-, wandplaatsing of in-de-dag
- **Kleuren:** wit gelakt RAL 9016 of zwart gelakt RAL 9005, andere kleuren op aanvraag
- **Stoffen:** zie Silent Gliss stoffencollectie

### **Kenmerken:**

- Zip technologie
- Stille en snelle motoren
- Soft stop
- Verschillende bedieningsmogelijkheden
- Zijgeleidingsprofiel 40 mm, voorgeboord

# SYSTEEMINFORMATIE

## A. SYSTEEM- AFMETINGEN

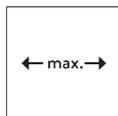

2.2 m

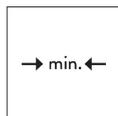

65 cm\*  
\*zie informatie motor

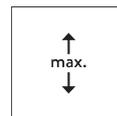

2.4 m

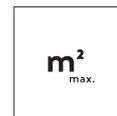

5.3 m<sup>2</sup>



3.7 kg

## B. PROFIEL

### Profielinformatie

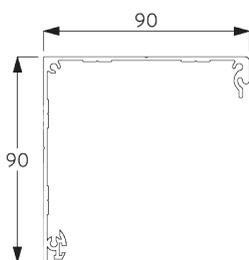

**SG 10996**

Bovenprofiel 90 mm

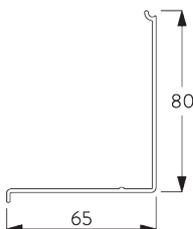

**SG 10997**

Bovenprofiel 90 mm

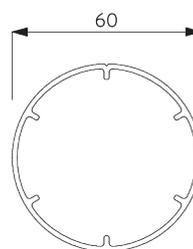

**SG 11037**

Profiel

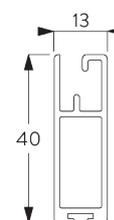

**SG 10993**

Verzwaringsprofiel rechthoek

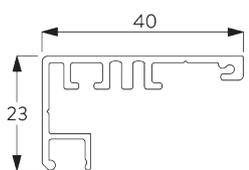

**SG 11418**

Zijgeleidingsprofiel

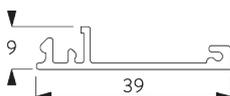

**SG 11419**

Zijgeleidingsprofiel

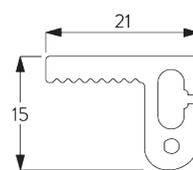

**SG 11421**

Zip profiel

## C. HOE TE METEN

### In-de-dag plaatsing

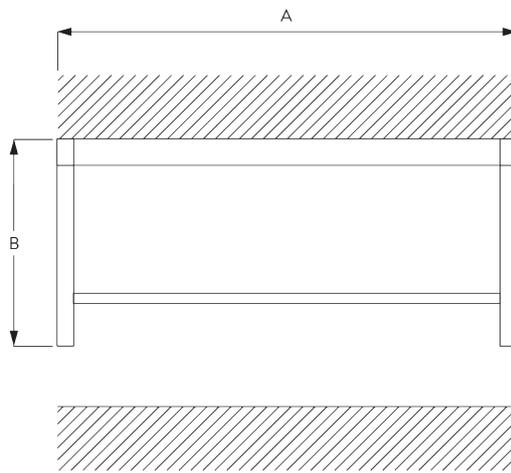

A: Systeembreedte  
B: Systeemhoogte

### Op-de-dag plaatsing

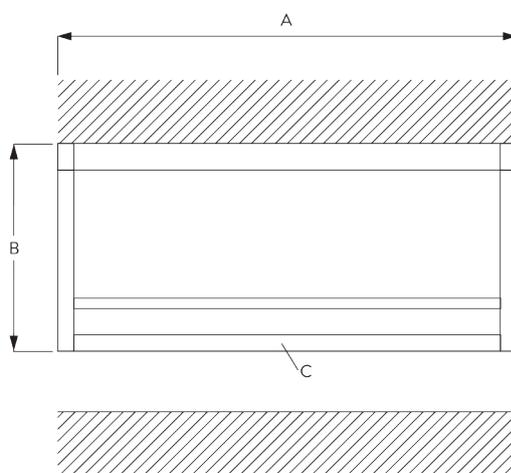

A: Systeembreedte  
B: Systeemhoogte  
C: Optioneel eindprofiel (SG 11418 / SG 11419)

# INSTALLATIE

## A. INSTALLATIE INFORMATIE

Bezoek onze *Silent Gliss* website voor gedetailleerde installatie informatie.

### In-de-dag plaatsing - bevestigingspunten

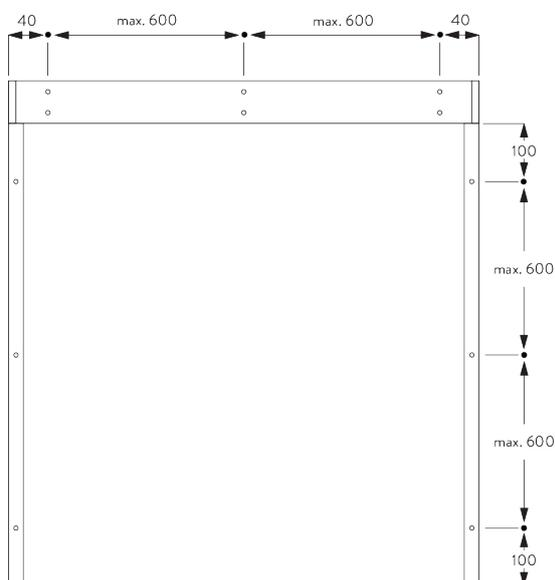

## Op-de-dag plaatsing - bevestigingspunten

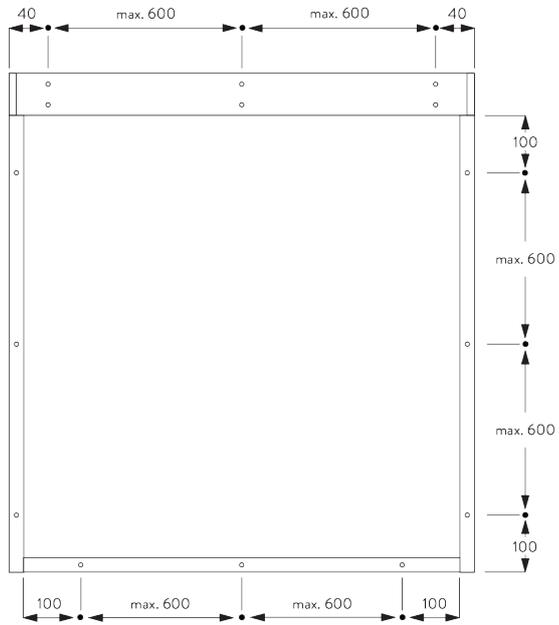

## B. PLAFOND- PLAATSING

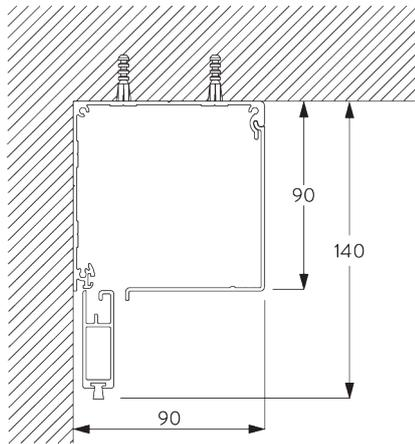

## C. WAND- PLAATSING

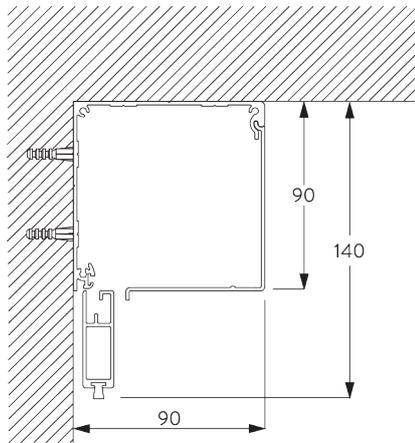

**D. INGEWERKTE  
PLAATSING**

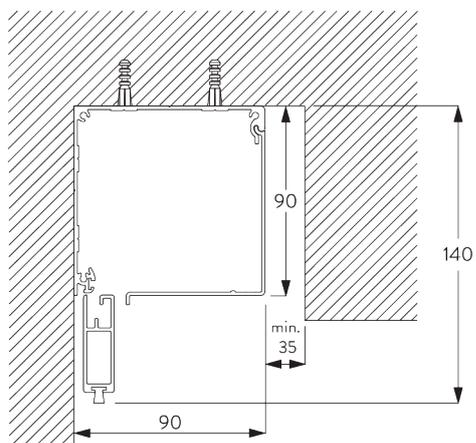

**E. ZIJGELEIDINGS-  
PROFIELEN  
SG 11418 / SG 11419**

**In-de-dag plaatsing**

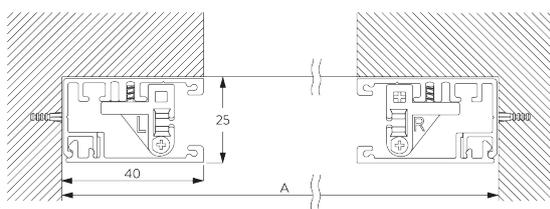

A: *Systeembreedte*

**Op-de-dag plaatsing**

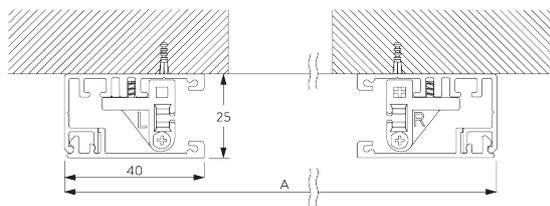

A: *Systeembreedte*

# MOTOREN EN BESTURINGSMOGELIJKHEDEN

## A. KENMERKEN

### MOTOR

Motoren	50-Series	20-Series	20-Series	10-Series K	5-Series
	SG 11251	SG 10523	SG 10522	SG 10514	SG 10715

#### Kenmerken

Soft stop	•	•	•		
Elektronische eindstop	•	•	•		
Electronic revolution counter (unlimited revolution)	•	•	•		
Mechanische eindstop				•	•
Mechanical revolution counter (limited revolution)				•	•
Twee tussenposities mogelijk		•			
Uitlijnen van de verzwaringsstaaf	•				
Geruisloze stop		•	•	•	
Parallelschakeling mogelijk zonder bijkomende relais		•	•		
Plug-in motorkabel	•	•	•		
IP klasse	IP 30	IP 44	IP 44	IP 44	IP 44

#### Aansturingsmogelijkheden

Netspanningsregeling		•	•	•	•
SG Control L (met ontvanger)		•			
Smart by Silent Gliss	•				
Geschikt voor alle domotica systemen		•	•	•	•

## B. INFORMATIE

### MOTOR

Motoren	Min. systeem breedte	Voltage	Ampère	Frequentie	Snelheid	Frequentie ontvanger
<b>50-Series (Smart by Silent Gliss)</b>						
SG 11251	65 cm	24 V DC	1.5 A	-	32 rpm	-
<b>20-Series</b>						
SG 10522 (standaard)	65 cm	230 V AC	0.55 A	50 Hz	30 rpm	-
SG 10523	65 cm	230 V AC	0.55 A	50 Hz	30 rpm	868/915 MHz
<b>10-Series K</b>						
SG 10514	65 cm	230 V AC	0.52 A	50 Hz	30 rpm	-
<b>5-Series</b>						
SG 10715	65 cm	230 V AC	0.485 A	50-60 Hz	28 rpm	-

## C. BESTURINGS- MOGELIJKHEDEN

Zie catalogus "controles" voor details.

Wandschakelaar



*Systeem kan worden bediend met vaste wandschakelaar.*

SG Control L



*Diverse draadloze hand- en wandzenders beschikbaar.*



*Silent Gliss Move App.*

Smart by Silent Gliss



*Open ontworpen tweewegcommunicatiesysteem waarmee de producten feilloos kunnen worden geïntegreerd met de meeste grote gebouwbeheersystemen.*

**D. AANSLUIT-  
SCHEMA'S**



*Raadpleeg onze Silent Gliss-website.*

# ONDERDELEN

## A. STANDAARD ONDERDELEN

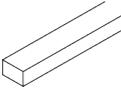
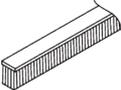
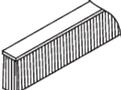
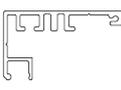
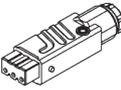
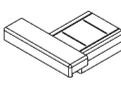
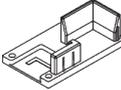
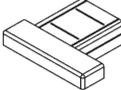
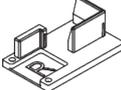
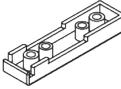
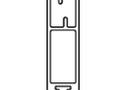
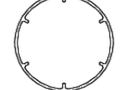
	<b>SG 4226</b> Kleefband 30 mm		<b>SG 11006</b> Afdekkap bovenprofiel 90 mm links		<b>SG 11060</b> Foam tape lijm
	<b>SG 4508</b> Borstel 5x7		<b>SG 11007</b> Afdekkap bovenprofiel 90 mm rechts		<b>SG 11324</b> Schroef KA35x14
	<b>SG 4509</b> Borstel 5x12		<b>SG 11011</b> Steun		<b>SG 11418</b> Zijgeleidingsprofiel
	<b>SG 6791</b> Schroef 3.9x32		<b>SG 11013</b> Steun motor		<b>SG 11419</b> Zijgeleidingsprofiel
	<b>SG 6933</b> Schroef KA25x16		<b>SG 11017</b> Adapter profiel 60 mm		<b>SG 11421</b> Zip profiel
	<b>SG 6936</b> Schroef KA22x10		<b>SG 11019</b> Adapter profiel 60 mm motorzijde		<b>SG 11473</b> Zip-gids links
	<b>SG 6942</b> Schroef KA30x8		<b>SG 11025</b> Zip band		<b>SG 11474</b> Zip-gids rechts
	<b>SG 9917</b> Hirschmann contra stekker		<b>SG 11028</b> Eindstuk verzwaringsprofiel links		<b>SG 11475</b> Einddeksel zijgeleider links
	<b>SG 10284</b> Ring		<b>SG 11029</b> Eindstuk verzwaringsprofiel rechts		<b>SG 11476</b> Zijgeleiding eindkap rechts
	<b>SG 10522</b> Motor 230V AC, 20-Series S 3/30		<b>SG 11030</b> Afdekstuk verzwaringsprofiel		
	<b>SG 10668</b> PVC strip en kleefband 10 mm		<b>SG 11034</b> Schroef 3.5x16		
	<b>SG 10993</b> Verzwaringsprofiel rechthoek		<b>SG 11035</b> Schroef 2.2x9.5		
	<b>SG 10996</b> Bovenprofiel 90 mm		<b>SG 11037</b> Profiel		
	<b>SG 10997</b> Bovenprofiel 90 mm		<b>SG 11059</b> Schroef M4x12		

## B. OPTIONELE ONDERDELEN

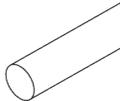
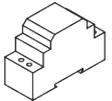
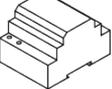
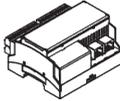
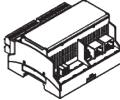
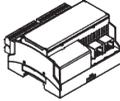
	<b>SG 4951</b> Gewicht		<b>SG 11263</b> Voeding 24V DC, 2.5 Ampère DIN rail
	<b>SG 9916</b> Hirschmann stekkerzet		<b>SG 11264</b> Voeding 24V DC, 3.8 Ampère DIN rail
	<b>SG 10293</b> Aansluitkabel 3, 5 en 10 m optioneel		<b>SG 11265</b> Voeding 24V DC, 5 Ampère DIN rail
	<b>SG 10300</b> Afstandsbediening, 1 kanaal		<b>SG 11266</b> Voeding 24V DC, 10 Ampère DIN rail
	<b>SG 10302</b> Afstandsbediening, 5+1 kanaal		<b>SG 11460</b> Afdekking voor Hirschmann-stekker
	<b>SG 10303</b> Afstandsbediening, 10+2+1 kanalen		<b>SG 11480</b> Wandchakelaar 1 kanaal
	<b>SG 10514</b> Motor 230V AC, 10 Series S 3/30 K		<b>SG 11490</b> Wandchakelaar 5+1 kanaal
	<b>SG 10523</b> Motor 230V AC, 20-Series S 3/30, radio ontvanger		
	<b>SG 10715</b> Motor 230V AC, 5 Series S 6/28		
	<b>SG 10804</b> Afstandsbediening 15 kanalen		
	<b>SG 11251</b> Motor 24V DC, 50-Series S 3/32		
	<b>SG 11260</b> Gateway Cedia		
	<b>SG 11261</b> Gateway KNX		
	<b>SG 11262</b> Uitbreidingseenheid		



# SG 4780

---

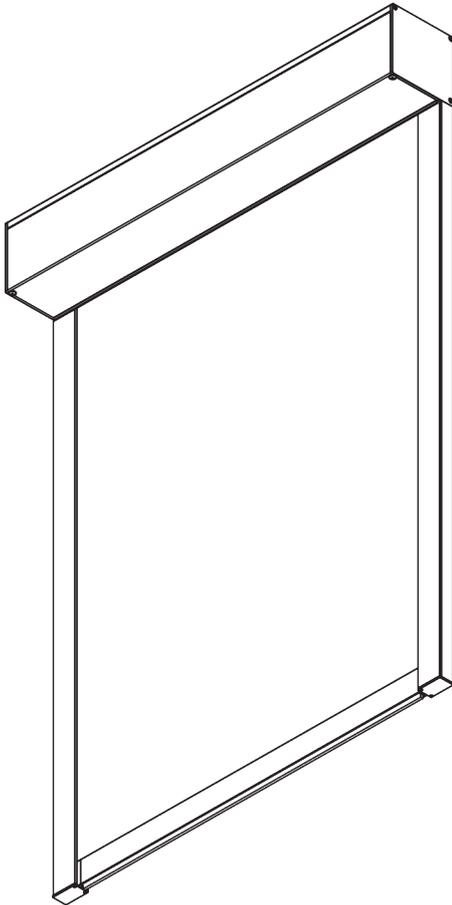
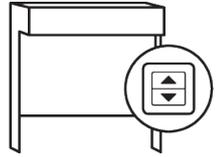

## PRODUCTINFORMATIE

- **Bediening:** elektrisch
- **Groep:** L
- **Installatie:** plafond-, wandplaatsing of in-de-dag
- **Kleuren:** wit gelakt RAL 9016 of zwart gelakt RAL 9005, andere kleuren op aanvraag
- **Stoffen:** zie Silent Gliss stoffencollectie

### **Kenmerken:**

- Zip technologie
- Stille en snelle motoren
- Soft stop
- Verschillende bedieningsmogelijkheden
- Zijgeleidingsprofiel 40 mm, voorgeboord

# SYSTEEMINFORMATIE

## A. SYSTEEM- AFMETINGEN

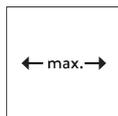

3 m

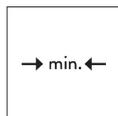

65 cm\*  
\*zie informatie motor

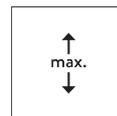

3 m

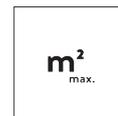

9 m<sup>2</sup>



6 kg

## B. PROFIEL

### Profielinformatie

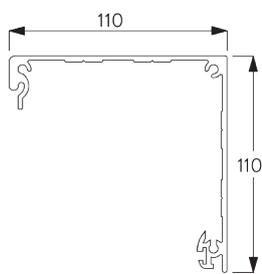

**SG 10998**

Bovenprofiel 110 mm

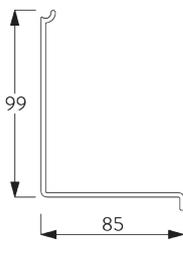

**SG 10999**

Bovenprofiel 110 mm

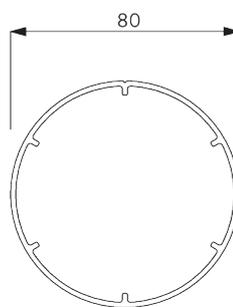

**SG 11003**

Profiel

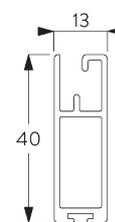

**SG 10993**

Verzwaringsprofiel rechthoek

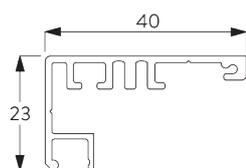

**SG 11418**

Zijgeleidingsprofiel

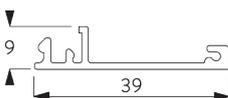

**SG 11419**

Zijgeleidingsprofiel

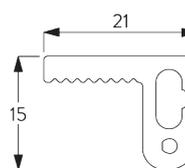

**SG 11421**

Zip profiel

## C. HOE TE METEN

### In-de-dag plaatsing

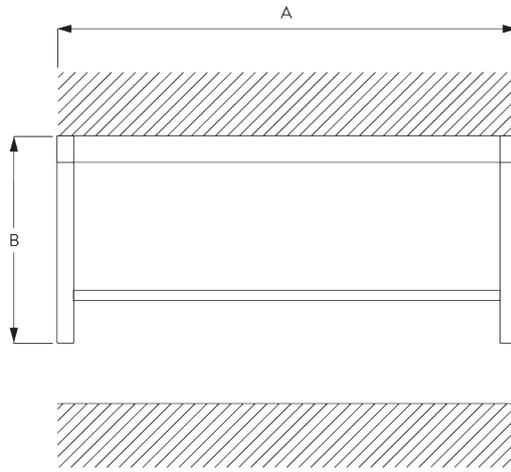

A: Systeembreedte  
B: Systeemhoogte

### Op-de-dag plaatsing

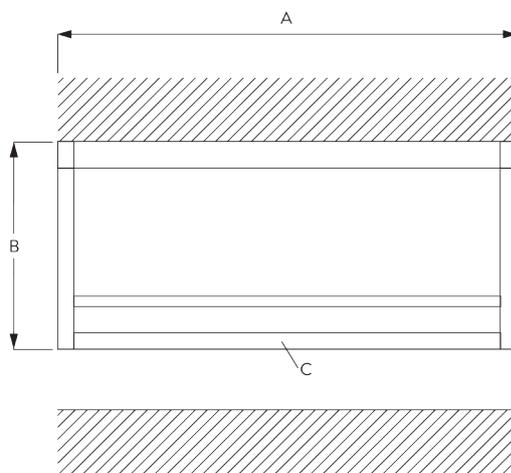

A: Systeembreedte  
B: Systeemhoogte  
C: Optioneel eindprofiel (SG 11418 / SG 11419)

# INSTALLATIE

## A. INSTALLATIE INFORMATIE

Bezoek onze *Silent Gliss* website voor gedetailleerde installatie informatie.

### In-de-dag plaatsing - bevestigingspunten

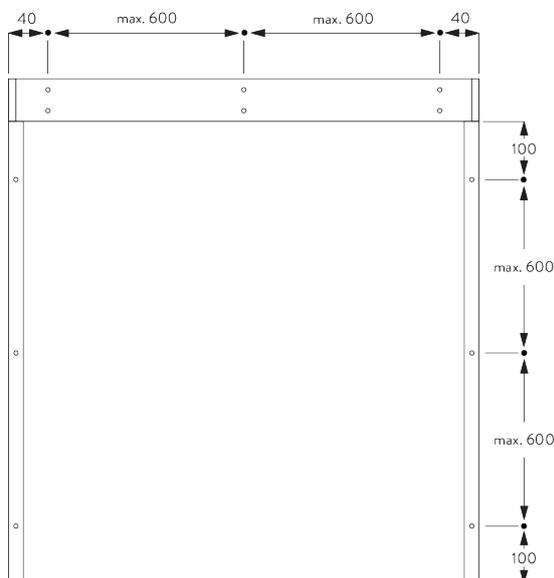

## Op-de-dag plaatsing - bevestigingspunten

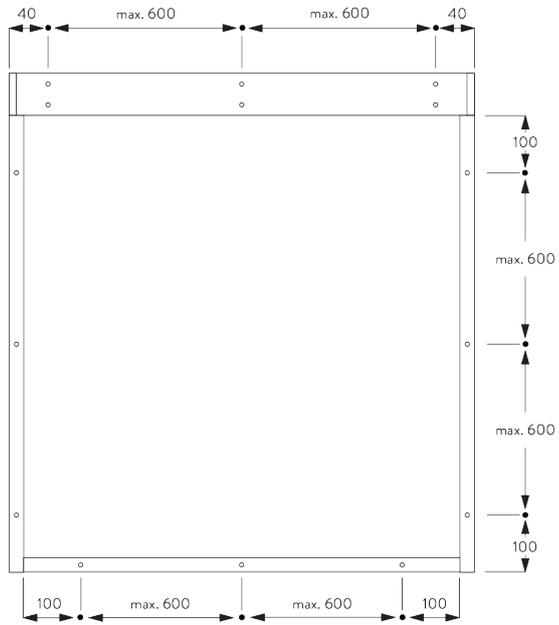

## B. PLAFOND- PLAATSING

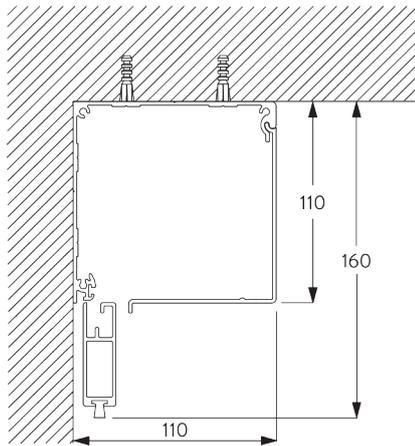

## C. WAND- PLAATSING

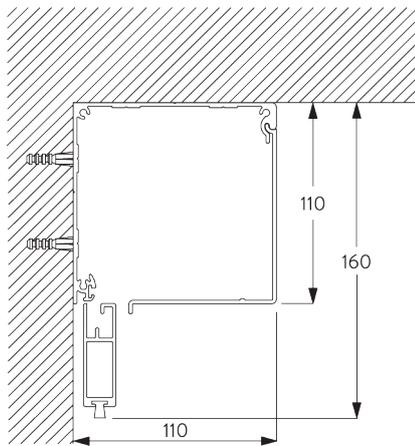

**D. INGEWERKTE  
PLAATSING**

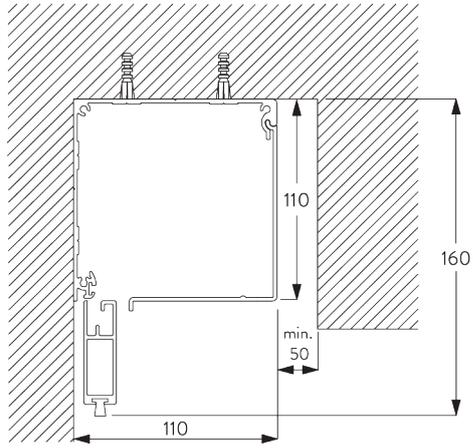

**E. ZIJGELEIDINGS-  
PROFIELEN  
SG 11418 / SG 11419**

**In-de-dag plaatsing**

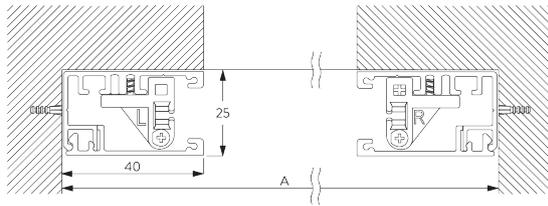

A: Systeembreedte

**Op-de-dag plaatsing**

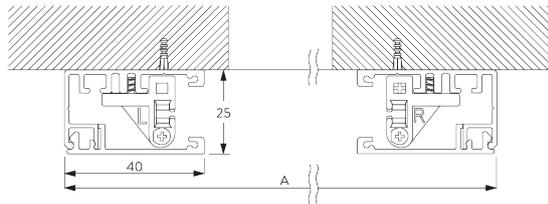

A: Systeembreedte

# MOTOREN EN BESTURINGSMOGELIJKHEDEN

## A. KENMERKEN

### MOTOR

Motoren	50-Series	20-Series	20-Series	10-Series K	5-Series
	SG 11251	SG 10523	SG 10522	SG 10514	SG 10715

#### Kenmerken

Soft stop	•	•	•		
Elektronische eindstop	•	•	•		
Electronic revolution counter (unlimited revolution)	•	•	•		
Mechanische eindstop				•	•
Mechanical revolution counter (limited revolution)				•	•
Twee tussenposities mogelijk		•			
Uitlijnen van de verzwaringsstaaf	•				
Geruisloze stop		•	•	•	
Parallelschakeling mogelijk zonder bijkomende relais		•	•		
Plug-in motorkabel	•	•	•		
IP klasse	IP 30	IP 44	IP 44	IP 44	IP 44

#### Aansturingsmogelijkheden

Netspanningsregeling		•	•	•	•
SG Control L (met ontvanger)		•			
Smart by Silent Gliss	•				
Geschikt voor alle domotica systemen		•	•	•	•

## B. INFORMATIE

### MOTOR

Motoren	Min. systeem breedte	Voltage	Ampère	Frequentie	Snelheid	Frequentie ontvanger
<b>50-Series (Smart by Silent Gliss)</b>						
SG 11251	65 cm	24 V DC	1.5 A	-	32 rpm	-
<b>20-Series</b>						
SG 10522 (standaard)	65 cm	230 V AC	0.55 A	50 Hz	30 rpm	-
SG 10523	65 cm	230 V AC	0.55 A	50 Hz	30 rpm	868/915 MHz
<b>10-Series K</b>						
SG 10514	65 cm	230 V AC	0.52 A	50 Hz	30 rpm	-
<b>5-Series</b>						
SG 10715	65 cm	230 V AC	0.485 A	50-60 Hz	28 rpm	-

## C. BESTURINGS- MOGELIJKHEDEN

Zie catalogus "controles" voor details.

**Wandschakelaar**



*Systeem kan worden bediend met vaste wandschakelaar.*

**SG Control L**



*Diverse draadloze hand- en wandzenders beschikbaar.*



*Silent Gliss Move App.*

**Smart by Silent Gliss**



*Open ontworpen tweewegcommunicatiesysteem waarmee de producten feilloos kunnen worden geïntegreerd met de meeste grote gebouwbeheersystemen.*

**D. WIRING**  
**DIAGRAMS**



*Refer to Silent Gliss website.*

# ONDERDELEN

## A. STANDAARD ONDERDELEN

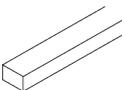
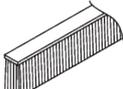
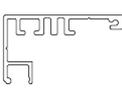
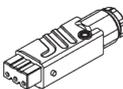
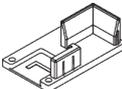
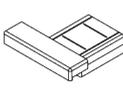
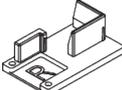
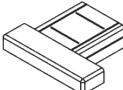
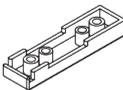
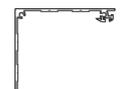
	<b>SG 4226</b> Kleefband 30 mm		<b>SG 11003</b> Profiel		<b>SG 11060</b> Foam tape lijm
	<b>SG 4508</b> Borstel 5x7		<b>SG 11008</b> Afdekkap bovenprofiel 110 mm links		<b>SG 11324</b> Schroef KA35x14
	<b>SG 4509</b> Borstel 5x12		<b>SG 11009</b> Afdekkap bovenprofiel 110 mm rechts		<b>SG 11418</b> Zijgeleidingsprofiel
	<b>SG 6791</b> Schroef 3.9x32		<b>SG 11011</b> Steun		<b>SG 11419</b> Zijgeleidingsprofiel
	<b>SG 6933</b> Schroef KA25x16		<b>SG 11013</b> Steun motor		<b>SG 11421</b> Zip profiel
	<b>SG 6936</b> Schroef KA22x10		<b>SG 11020</b> Adapter profiel 80 mm		<b>SG 11473</b> Zip-gids links
	<b>SG 6942</b> Schroef KA30x8		<b>SG 11022</b> Adapter profiel 80 mm motorzijde		<b>SG 11474</b> Zip-gids rechts
	<b>SG 9917</b> Hirschmann contra stekker		<b>SG 11025</b> Zip band		<b>SG 11475</b> Einddeksel zijgeleider links
	<b>SG 10284</b> Ring		<b>SG 11028</b> Eindstuk verzwaringsprofiel links		<b>SG 11476</b> Zijgeleiding eindkap rechts
	<b>SG 10522</b> Motor 230V AC, 20-Series S 3/30		<b>SG 11029</b> Eindstuk verzwaringsprofiel rechts		
	<b>SG 10668</b> PVC strip en kleefband 10 mm		<b>SG 11030</b> Afdekstuk verzwaringsprofiel		
	<b>SG 10993</b> Verzwaringsprofiel rechthoek		<b>SG 11034</b> Schroef 3.5x16		
	<b>SG 10998</b> Bovenprofiel 110 mm		<b>SG 11035</b> Schroef 2.2x9.5		
	<b>SG 10999</b> Bovenprofiel 110 mm		<b>SG 11059</b> Schroef M4x12		

## B. OPTIONELE ONDERDELEN

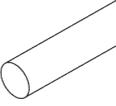
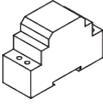
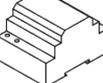
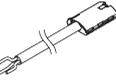
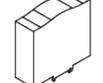
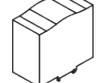
	<b>SG 4951</b> Gewicht		<b>SG 11263</b> Voeding 24V DC, 2.5 Ampère DIN rail
	<b>SG 9916</b> Hirschmann stekkerzet		<b>SG 11264</b> Voeding 24V DC, 3.8 Ampère DIN rail
	<b>SG 10293</b> Aansluitkabel 3, 5 en 10 m optioneel		<b>SG 11265</b> Voeding 24V DC, 5 Ampère DIN rail
	<b>SG 10300</b> Afstandsbediening, 1 kanaal		<b>SG 11266</b> Voeding 24V DC, 10 Ampère DIN rail
	<b>SG 10302</b> Afstandsbediening, 5+1 kanaal		<b>SG 11460</b> Afdekking voor Hirschmann-stekker
	<b>SG 10303</b> Afstandsbediening, 10+2+1 kanalen		<b>SG 11480</b> Wandchakelaar 1 kanaal
	<b>SG 10514</b> Motor 230V AC, 10 Series S 3/30 K		<b>SG 11490</b> Wandchakelaar 5+1 kanaal
	<b>SG 10523</b> Motor 230V AC, 20-Series S 3/30, radio ontvanger		
	<b>SG 10715</b> Motor 230V AC, 5 Series S 6/28		
	<b>SG 10804</b> Afstandsbediening 15 kanalen		
	<b>SG 11251</b> Motor 24V DC, 50-Series S 3/32		
	<b>SG 11260</b> Gateway Cedia		
	<b>SG 11261</b> Gateway KNX		
	<b>SG 11262</b> Uitbreidingseenheid		





## ***De architecten van de stilte***

***Silent Gliss is de toonaangevende wereldwijde leverancier van hoogwaardige raambekeding voor het interieur. Sinds 1952 hebben wij ons onvermoeibaar ingezet voor de ontwikkeling van de soepelste en stilste systemen ter wereld met behulp van de modernste technologie.***

*Gedreven door de behoeften van de klant, biedt Silent Gliss functionele en duurzame producten. Deskundig technisch advies in combinatie met installatie- en ondersteuningsdiensten maken het aanbod compleet. Silent Gliss staat voor innovatieve, duurzame, op maat gemaakte oplossingen, een uitzonderlijk design en topkwaliteit.*

### **Silent Gliss Benelux**

België – Belgique

**T** +32 2 240 03 60

**F** +32 2 240 03 69

[info@silentgliss.be](mailto:info@silentgliss.be)

**[silentgliss.be](http://silentgliss.be)**

**[silentgliss.nl](http://silentgliss.nl)**