

SG 2740

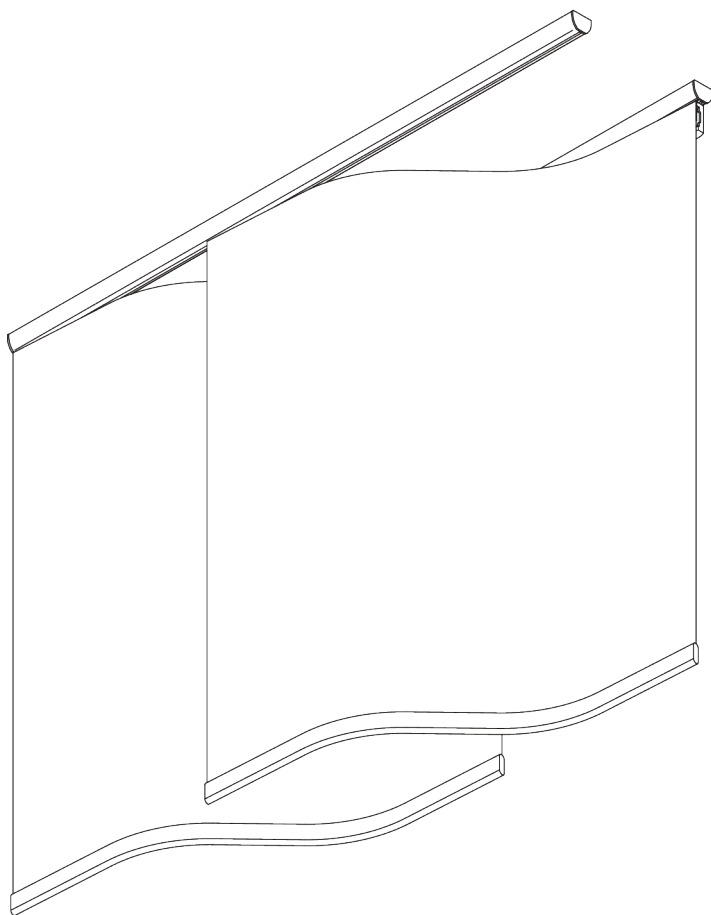

WAVE PANEL



PRODUCTINFORMATIE

- **Bediening:** hand
- **Groep:** S - L
- **Installatie:** plafond
- **Kleuren:** wit gelakt RAL 9016
- **Stoffen:** zie Silent Gliss stoffencollectie

Kenmerken:

- Golfvormige panelen
- Eenvoudige inklikbare trekwagen voor snelle installatie
- Vrijhangende of gekoppelde panelen

SYSTEEMINFORMATIE

A. SYSTEEM- AFMETINGEN

Vaste paneelbreedte 50
cm

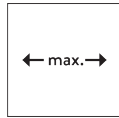

Ongekoppelde panelen:
ongelimiteerd

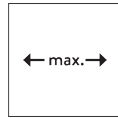

Gekoppelde panelen
(max. 15 panelen): 6.05
m

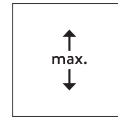

2.8 m



1 kg
incl. verzwarringsstaaf per
paneel

Ongekoppelde panelen

Systeemafmeting in cm	Aantal panelen	Overlapping in cm
100 - 136	3	18.1 - 0.1
137 - 181	4	14.9 - 0.2
182 - 226	5	11.2 - 0.2
227 - 272	6	9.1 - 0.1
273 - 317	7	7.5 - 0.1
318 - 363	8	6.4 - 0.0
364 - 408	9	5.6 - 0.1
409 - 453	10	5.0 - 0.1
454 - 499	11	4.5 - 0.0
500 - 544	12	4.1 - 0.1
545 - 590	13	3.8 - 0.0
591 - 635	14	3.4 - 0.0
636 - 680	15	3.2 - 0.1

Gekopplde panelen

Max. 15 panelen

Systeemafmeting in cm	Aantal panelen	Totale breedte van de panelen (cm)
100 - 125	3	125
126 - 165	4	165
166 - 205	5	205
206 - 245	6	245
246 - 285	7	285
286 - 325	8	325
326 - 365	9	365
366 - 405	10	405
406 - 445	11	445
446 - 485	12	485
486 - 525	13	525
526 - 565	14	565
566 - 605	15	605

B. PROFIEL

Profielinformatie

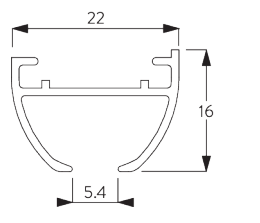

SG 6010p

Profiel

C. HOE TE METEN

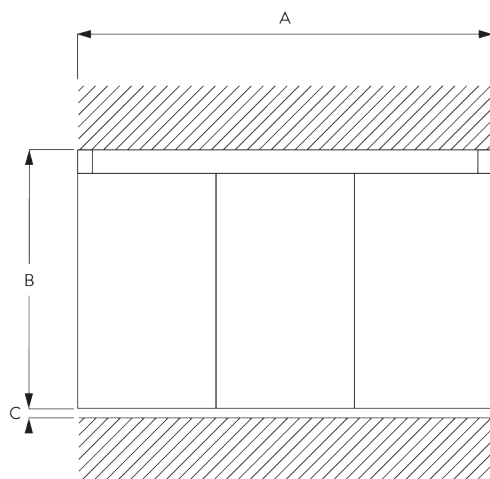

A: Systeembreedte

B: Systeemhoogte

C: Afstand tussen vloer en onderkant sto

Pakketbreedte

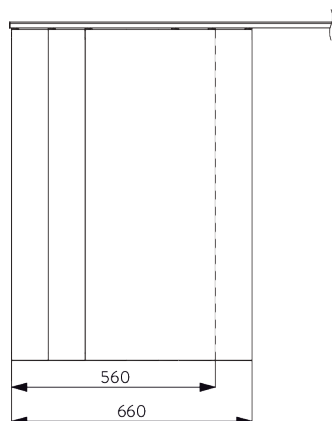

2 panelen: 560 mm

3 panelen: 660 mm

4 panelen: 760 mm

5 panelen: 860 mm

Per extra paneel: 100 mm.

Paneelopening

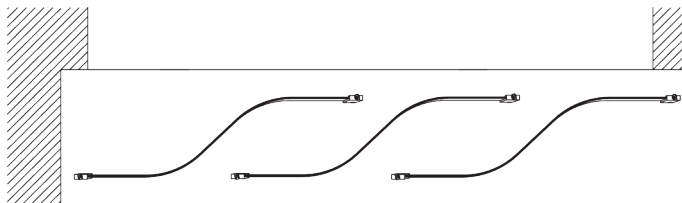

Trekwagen A (standaard)

Openen van de panelen is naar de linker zijde van de ruimte.

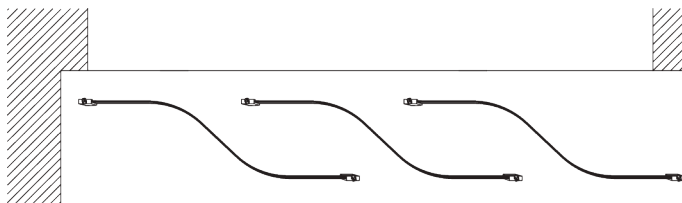

Trekwagen B (optie)

Openen van de panelen is naar de rechter zijde van de ruimte.

INSTALLATIE

A. INSTALLATIE INFORMATIE

Bezoek onze *Silent Gliss* website voor gedetailleerde installatie informatie.

Bevestigingspunten

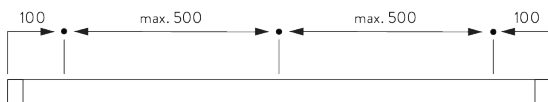

B. PLAFOND- PLAATSING

Spanner SG 3825

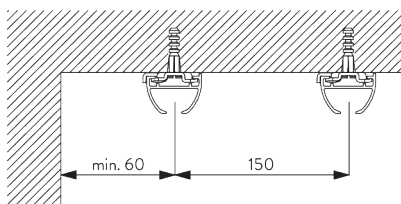

Afstand tussen de profielen: 15 cm

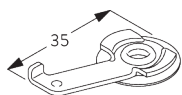

SG 3825

Spanner

ONDERDELEN

A. STANDAARD ONDERDELEN



SG 2539

Klittenband



SG 3825

Spanner

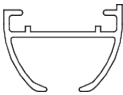

SG 6010p

Profiel

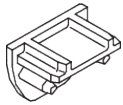

SG 6018

Eindstuk



SG 11104

Trekwagen A



SG 11107

Verzwaringsstaaf



SG 11161

Koord met glijder, 40 cm

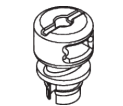

SG 11162

Click glijder

B. OPTIONELE ONDERDELEN

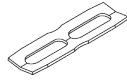

SG 3802

Verbindingsstuk



SG 11109

Trekwagen B

