

SG 2810

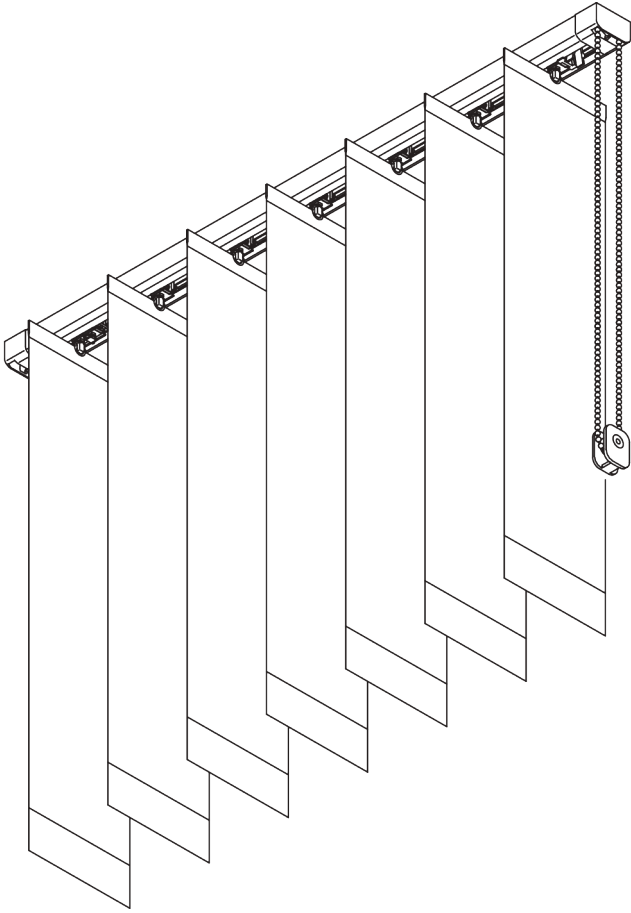
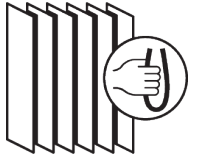

PRODUCTINFORMATIE

- **Bediening:** ketting
- **Groep:** S - M
- **Installatie:** plafond-, wandplaatsing of inbouw
- **Kleuren:** wit gelakt RAL 9016 of aluminium geanodiseerd, andere kleuren op aanvraag
- **Stoffen:** zie Silent Gliss stoffencollectie

Kenmerken:

- Geoptimaliseerde lichtregeling
- Monobediening
- Pull override bescherming
- Lamelbreedte: 127 mm (standaard), 89 mm
- Vertical Waves, buigbaar

04/2024/V1

SYSTEEMINFORMATIE

A. SYSTEEM- AFMETINGEN



127 mm lamellen: 5 m
89 mm lamellen: 3.8 m



40 cm



4 m



200 g per lamel

Max. systeembreedte

	127 mm 89 mm	5 m 3.8 m
	127 mm 89 mm	4 m 3.1 m
	127 mm 89 mm	4 m 3.1 m

Pakketbreedte

		100	150	200	250	300	350	400	450	500
127 mm		27	35	42	50	57	65	72	80	87
		21	25	28	32	36	39	43	47	50
89 mm		29	40	50	60	69	80			
		20	25	30	35	39	45			

(cm)

B. PROFIEL

Profiel- en buiginformatie

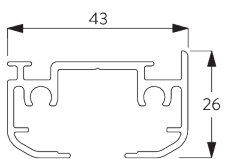

SG 2601

Profiel

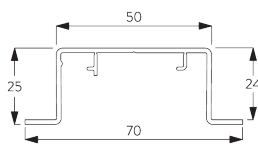

SG 2615

Inbouwprofiel



Radius:
>75 cm

C. HOE TE METEN

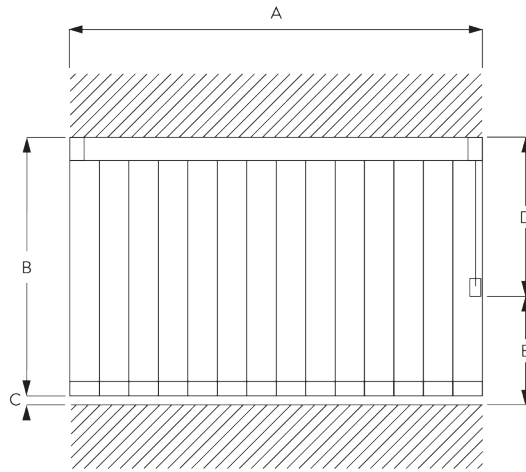

- A: Systeembreedte
- B: Systemhoogte
- C: Afstand tussen vloer en onderkant stof
- D: Kettinghoogte
- E: Safety retainer SG 10731 min. 150 cm boven de vloer

Lichtopening

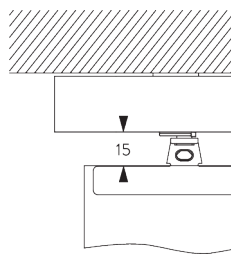

INSTALLATIE

A. INSTALLATIE INFORMATIE

Bezoek onze *Silent Gliss* website voor gedetailleerde installatie informatie.

Bevestigingspunten

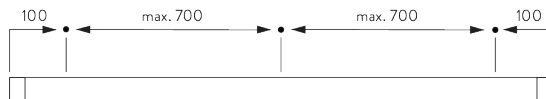

B. PLAFOND- PLAATSING

Steun SG 2616

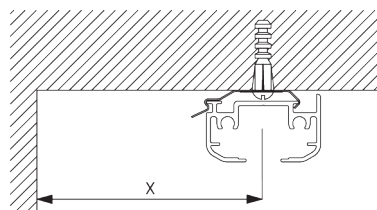

Min. afstand vanaf de wand	X mm
89 mm	65
127 mm	85
Vertical Waves 89 mm	115
Vertical Waves 125 mm	140

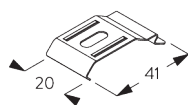

SG 2616
Plafondsteun

C. INBOUW

Inbouwprofiel SG 2615

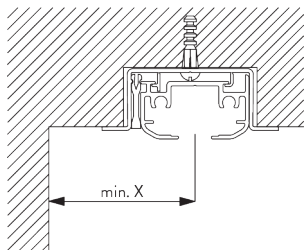

Inbouwprofiel SG 2615 kan niet gebogen worden!
Per bevestigingspunt is er een klem SG 5118 nodig.
Bezoek onze Silent Gliss website voor gedetailleerde
installatie informatie.

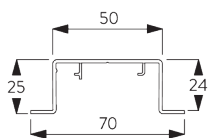

SG 2615
Inbouwprofiel

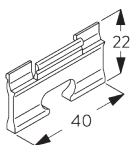

SG 5118
Klemstuk

Min. afstand vanaf de wand	X mm
89 mm	65
127 mm	85
Vertical Waves 89 mm	115
Vertical Waves 125 mm	140

D. WAND- PLAATSING

Smart Fix

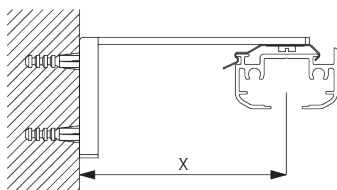

Smart Fix SG 11201 - SG 11204
en steun SG 2616:
Schroef SG 10395 (M4x6) nodig.

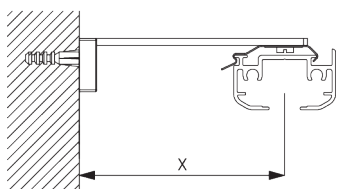

Square Smart Fix SG 11211 - SG 11214
en steun SG 2616:
Schroef SG 10395 (M4x6) nodig.

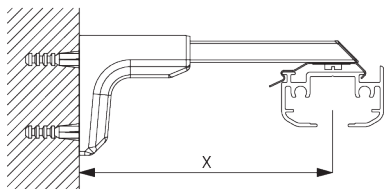

Universal Smart Fix SG 11154 - SG 11156
en steun SG 2616:
Schroef SG 10492 (M4x8) nodig.

Smart Fix	X mm
SG 11201 / SG 11211	72
SG 11202 / SG 11212	92
SG 11203 / SG 11213	112
SG 11204 / SG 11214	142
SG 11154	102-130
SG 11155	132-160
SG 11156	182-210

Min. afstand vanaf de wand	X mm
89 mm	65
127 mm	85
Vertical Waves 89 mm	115
Vertical Waves 125 mm	140

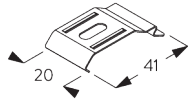

SG 2616
Plafondsteun



SG 10395
Schroef M4x6



SG 10492
Schroef M4x8

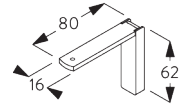

SG 11201
Smart Fix 80 mm

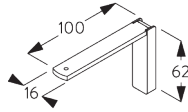

SG 11202
Smart Fix 100 mm

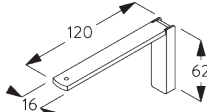

SG 11203
Smart Fix 120 mm

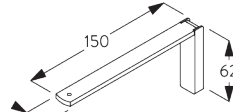

SG 11204
Smart Fix 150 mm

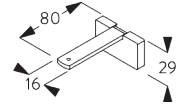

SG 11211
Square Smart Fix 80 mm

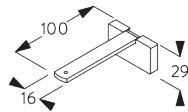

SG 11212
Square Smart Fix 100 mm

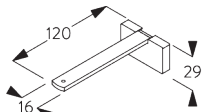

SG 11213
Square Smart Fix 120 mm

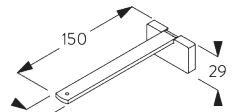

SG 11214
Square Smart Fix 150 mm

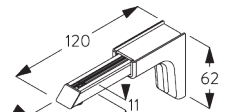

SG 11154
Universal Smart Fix, 120 mm

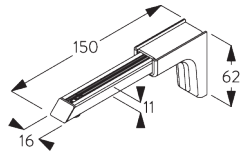

SG 11155
Universal Smart Fix, 150 mm

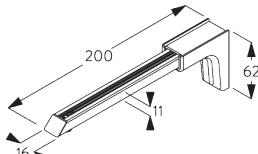

SG 11156
Universal Smart Fix, 200 mm

SYSTEEMOPTIES

A. VERTICAL WAVES

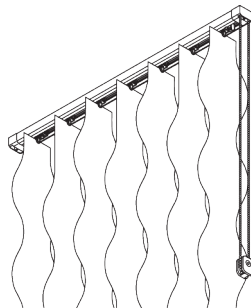

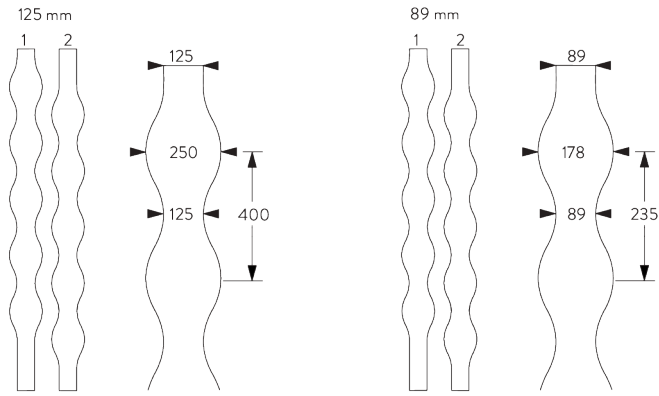

3D Vertical Waves is enkel mogelijk met 125 mm lamellen.

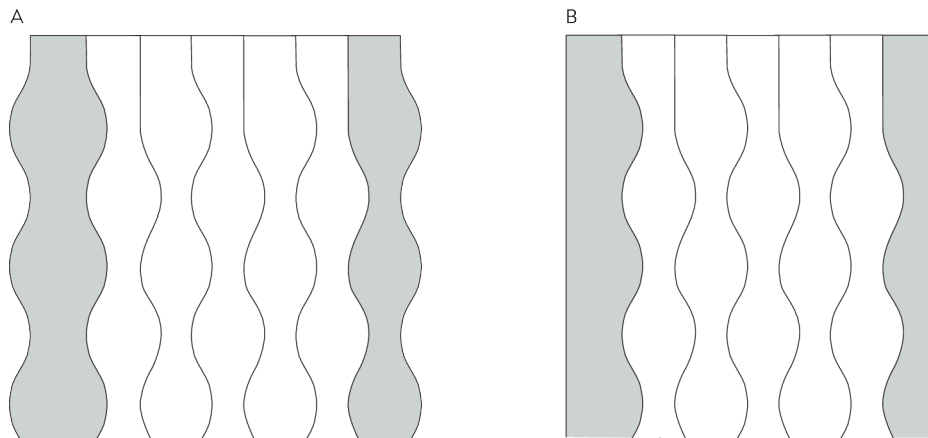

Tegen de wand

A: Golvende lamel

B: Rechte lamel

B. PAKKET- VERDELINGEN

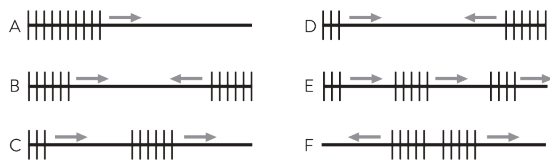

A: 1-delig pakket in één richting

B: 2-delig pakket in twee richtingen symmetrisch

C: 2-delig pakket in één richting asymmetrisch

D: 2-delig pakket in twee richtingen asymmetrisch

E: Meerdere pakketten in één richting asymmetrisch

F: 2-delig pakket uiteenlopend

ONDERDELEN

A. STANDAARD ONDERDELEN

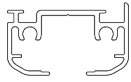

SG 2601

Profiel

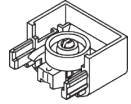

SG 2604

Poelie

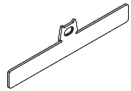

SG 2605

Bovenplaatje 127 mm

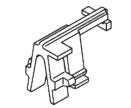

SG 2610

Eindstop

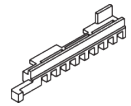

SG 2611

Stop

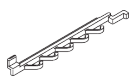

SG 2612

Rem

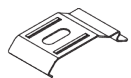

SG 2616

Plafondsteun

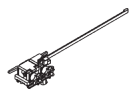

SG 2620

Voorloper



SG 2623

Set rotatie element 127 mm

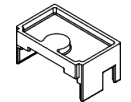

SG 2627

Afdeksluk



SG 2865

Kettingverbinding \varnothing 4.6 mm



SG 2872

Kunststof ketting \varnothing 4.6 mm



SG 2888

Ketting voor lamellen 127 mm

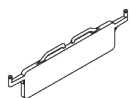

SG 2892

Verzwaringsplaatje 127 mm

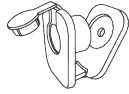

SG 10731

Safety Retainer set (incl. bevestigingsmiddelen & waarschuwingsboekje)

B. OPTIONELE ONDERDELEN

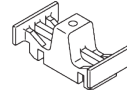

SG 2608

Eindstop

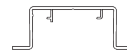

SG 2615

Inbouwprofiel

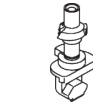

SG 2618

As voor in lamelglijder



SG 2624

Set rotatie element 100 mm



SG 2625

Set rotatie element 89 mm



SG 2735

Houder

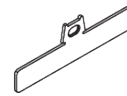

SG 2813

Bovenplaatje 89 mm

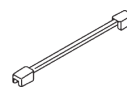

SG 2881

Veer

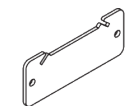

SG 2884

Verzwaringsplaatje 89 mm



SG 2889

Ketting voor lamellen 89 mm

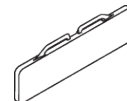

SG 2890

Verzwaringsplaatje 127 mm



SG 3340

Koordgewicht

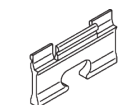

SG 5118

Klemstuk



SG 10395

Schroef M4x6

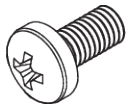

SG 10492

Schroef M4x8

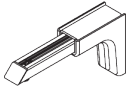

SG 11154

Universal Smart Fix, 120 mm

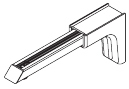

SG 11155

Universal Smart Fix, 150 mm

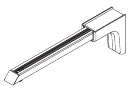

SG 11156

Universal Smart Fix, 200 mm

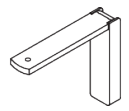

SG 11201

Smart Fix 80 mm

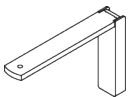

SG 11202

Smart Fix 100 mm

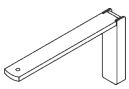

SG 11203

Smart Fix 120 mm

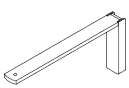

SG 11204

Smart Fix 150 mm

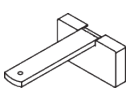

SG 11211

Square Smart Fix 80 mm

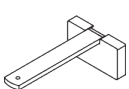

SG 11212

Square Smart Fix 100 mm

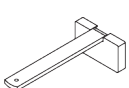

SG 11213

Square Smart Fix 120 mm

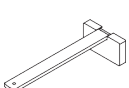

SG 11214

Square Smart Fix 150 mm